

F8

MultiTrack Field Recorder

Operation Manual

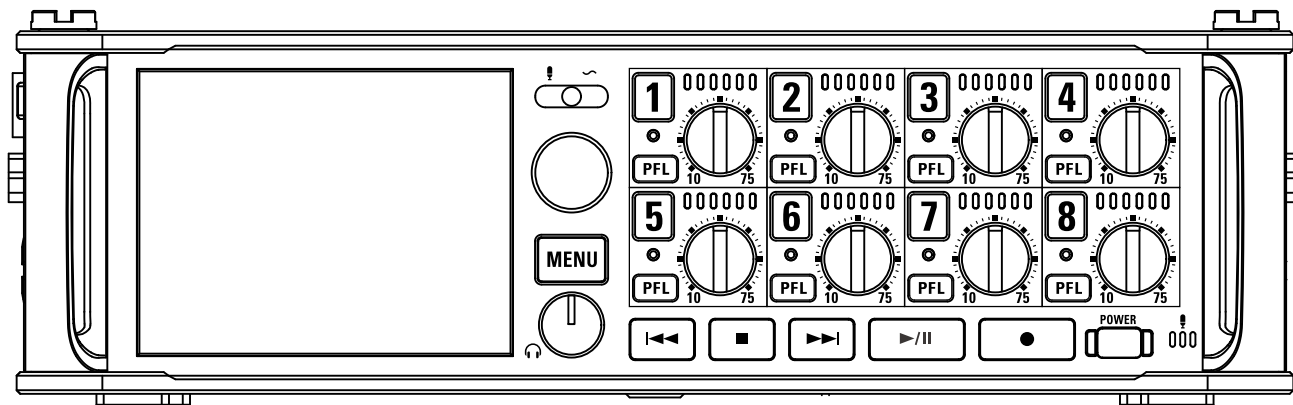

Contents

Contents	02
Usage and Safety Precautions.....	04
Introduction.....	05
Names of parts.....	06
Connecting mics/other devices to Inputs 1–8.....	08
LCD display	11

Preparations

Supplying power	15
Loading an SD card	17
Turning the power on and off.....	18
Setting the date and time (Date/Time (RTC)).....	19
Disabling the Automatic Power Saving function (Auto Power Off).....	21
Setting the power supply used (Power Source).....	22

Recording

Recording process	24
Enabling recording on SD cards and setting file formats	25
Selecting inputs and adjusting levels	27
Recording	29
Setting the sampling rate (Sample Rate).....	30
Setting WAV file bit depth (WAV Bit Depth).....	31
Setting MP3 file bit rate (MP3 Bit Rate).....	32
Simultaneously recording tracks at different levels (Dual Channel Rec) ...	33
Capturing audio before recording starts (Pre Rec)	35
Maximum file size (File Max Size).....	36
Showing total recording times for long recordings (Time Counter).....	37
Folder and file structure	38
Moving the previously recorded take to the FALSETAKE folder.....	40

Recording take settings

Changing the note for the next take recorded (Note).....	41
Setting how recorded scenes are named and numbered	43
Setting the take name reset condition and format	46
Changing the track name of the next take recorded (Track Name)	48
Changing the number of the next take recorded.....	50

Playback

Playing recordings.....	51
Mixing takes	52
Monitoring the playback signals of specific tracks during playback	53
Changing the playback mode (Play Mode).....	54

Take and folder operations

Take and folder operations (FINDER).....	55
Overview of take information (metadata) stored in files	62
Checking and editing take metadata.....	64
Writing sound reports (Create Sound Report).....	71

Input settings

Input and output signal flow.....	74
Adjusting the input signal monitoring balance.....	75
Setting the track knob function (Track Knob Option)	76
Adjusting the L/R track volume.....	78
Monitoring the input signals of specific tracks (PFL/SOLO).....	79
Setting the input source (Input Source).....	80
Setting the monitoring volume on the PFL screen (PFL Mode).....	81
Cutting low-frequency noise (HPF)	82
Input limiter.....	83
Inverting the input phase (Phase Invert).....	89
Changing the phantom power settings (Phantom)	90
Changing the plugin power setting (Plugin Power).....	93
Delaying input signals (Input Delay).....	94
Converting mid-side input to ordinary stereo (Stereo Link Mode).....	95
Adjusting the input levels of multiple tracks simultaneously (Trim Link) ...	97
Adjusting the side level of a mid-side mic capsule (Side Mic Level)	98
Changing the automatic mixing setting (Auto Mix)	99
Setting the format of Ambisonic Mode	101
Setting the mic position used for ambisonic recording (Mic Position).....	106

Output settings

Setting signals sent to headphones (Headphone Routing).....	108
Outputting alerts through headphones (Alert Tone Level)	111
Setting the headphone output (Volume Curve)	112

Boosting headphone output to alleviate interference from recorded sound (Digital Boost)	113
Disabling outputs (Output On/Off)	114
Setting the standard output level (Output Level).....	115
Setting output levels	116
Delaying output signals (Output Delay).....	117
Output Limiter.....	118
Selecting signals sent to the main outputs (MAIN OUT Routing).....	122
Selecting signals sent to the sub outputs (SUB OUT Routing)	123

Timecode

Timecode overview	124
Setting timecode functions.....	126
Setting automatic timecode recording delay (Auto Rec Delay Time).....	133
Setting timecode initialization used at startup (Start Timecode)	134

Slate mic/slate tone

Slate mic and slate tone overview	136
Recording with the slate mic (Slate Mic)	137
Recording a slate tone (Slate Tone)	140

Using USB functions

Exchanging data with a computer (SD Card Reader)	144
Using as an audio interface (Audio Interface).....	145
Using SD card recording and audio interface functions at the same time (Audio Interface with Rec)	147
Audio interface block diagrams.....	149
Audio interface settings	151

Using an FRC-8

Using an FRC-8 as a controller (Connect).....	152
Setting the type of keyboard connected to the FRC-8 (Keyboard Type) ...	153
Setting FRC-8 fader and knob operation (Knob/Fader Mode).....	154
Setting user keys for the FRC-8 (User Key).....	155
Setting the power supply used by the FRC-8 (Power Source)	156
Setting the FRC-8 LED brightness (LED Brightness).....	157
Updating the FRC-8 firmware	158

Various settings

Setting how timecode is shown (Home Timecode Display Size).....	160
Setting level meter appearance (Level Meter)	161
Setting the LED brightness (LED Brightness)	166
Making display settings (LCD).....	167
Adding marks when pausing (PLAY Key Option).....	170
Setting the keys held (Key Hold Target)	171

Other functions

Checking SD card information (Information)	172
Testing SD card performance (Performance Test).....	173
Formatting SD cards (Format)	176
Checking the F8 Shortcut List.....	177
Backing up and loading F8 settings (Backup/Load Settings)	178
Restoring default setting values (Factory Reset).....	180
Checking the firmware version (Firmware Version).....	181
Updating the firmware.....	182

Appendices

Troubleshooting.....	183
Detailed product diagrams	184
Metadata list	186
List of shortcuts	190
Specifications.....	192

Usage and Safety Precautions

Safety Precautions

In this operation manual, symbols are used to highlight warnings and cautions that you must read to prevent accidents. The meanings of these symbols are as follows.



Something that could cause serious injury or death.



Something that could cause injury or damage to the equipment.

Other symbols used



An action that is mandatory.



An action that is prohibited.



Warning

Operation using an AC adapter

- ❗ Never use any AC adapter other than a ZOOM AD-19.

Operation with external DC power supply

- ❗ Use a 9V–16V external DC power supply.
- ❗ Carefully study the warning indications of the external DC power supply before use.

Operation with batteries

- ❗ Use 8 commercially-available 1.5V AA batteries (alkaline dry cell batteries, nickel metal hydride batteries or lithium dry cell batteries).
- ❗ Carefully study the warning indications of the batteries before use.
- ❗ Always keep the battery cover closed during use.

Alterations

- ⊘ Do not open the case or modify the product.



Caution

Product handling

- ❗ Do not drop, bump or apply excessive force to the unit.
- ❗ Be careful not to allow foreign objects or liquids to enter the unit.

Operating environment

- ⊘ Do not use in extremely high or low temperatures.
- ⊘ Do not use near heaters, stoves and other heat sources.
- ⊘ Do not use in very high humidity or where it could be splashed by water.
- ⊘ Do not use in places with frequent vibrations.
- ⊘ Do not use in places with much dust or sand.

AC adapter handling

- ❗ When disconnecting the power plug from an outlet, always pull on the plug itself.
- ❗ Disconnect the power plug from the outlet when the unit will not be used for extended periods and whenever there is lightning.

Battery handling

- ❗ Install batteries with the correct +/- orientations.
- ❗ Use the specified batteries. Do not use new and old batteries together. Do not use batteries of different brands or types together.
- ❗ Remove the batteries when the unit will not be used for extended periods. If a leak occurs, thoroughly wipe the battery case and battery terminals to remove the leaked fluid.
- ❗ Danger of explosion if battery is incorrectly replaced. Replace only with the same or equivalent type.
- ❗ A warning that batteries (battery pack or batteries installed) shall not be exposed to excessive heat such as sunshine, fire or the like.

Mic handling

- ❗ Always turn the power switch OFF before connecting a mic. Do not apply unnecessary force when connecting a mic.
- ❗ Attach the protective cap when no mic is connected for extended periods.

Connection cables and input/output jacks

- ❗ Always turn the power OFF for all equipment before connecting any cables.
- ❗ Always disconnect all connection cables and the AC adapter before moving the unit.

Volume

- ⊘ Do not use at a loud volume for extended periods.

Usage Precautions

Interference with other electrical equipment

In consideration of safety, the **FE** has been designed to minimize its emission of electromagnetic waves and to suppress interference from external electromagnetic waves. However, equipment that is very susceptible to interference or that emits powerful electromagnetic waves could result in interference if placed nearby. If this occurs, place the **FE** and the other device farther apart. With any type of electronic device that uses digital control, including the **FE**, electromagnetic interference could cause malfunction, corrupt or destroy data and result in other unexpected trouble. Always use caution.

Cleaning

Use a soft cloth to clean the exterior of the unit if it becomes dirty. If necessary, use a damp cloth that has been wrung out well to wipe it. Never use abrasive cleansers, wax or solvents such as alcohol, benzene or paint thinner.

Breakdown and malfunction

If the unit becomes broken or malfunctions, immediately disconnect the AC adapter or DC power supply, turn the power off and disconnect other cables. Contact the store where you bought the unit or ZOOM service center with the following information: product model, serial number and specific symptoms of break-

down or malfunction, along with your name, address and telephone number.

Copyrights

© Windows® and Windows® 7 are trademarks or registered trademarks of Microsoft® Corporation.
© Macintosh, Mac OS and iPad are trademarks or registered trademarks of Apple Inc.
© The SD, SDHC and SDXC logos are trademarks. MPEG Layer-3 audio compression technology is licensed from Fraunhofer IIS and Sivel S.p.A.
© Bluetooth and the Bluetooth logo are registered trademarks of Bluetooth SIG, Inc. and are used under license by ZOOM CORPORATION.
© Other product names, registered trademarks and company names in this document are the property of their respective companies.

Note: All trademarks and registered trademarks in this document are for identification purposes only and are not intended to infringe on the copyrights of their respective owners.

Recording from copyrighted sources, including CDs, records, tapes, live performances, video works and broadcasts, without permission of the copyright holder for any purpose other than personal use is prohibited by law. ZOOM CORPORATION will not assume any responsibility related to infringements of copyrights.

Note about the Auto Power Off function

The power will automatically turn off if unused for 10 hours. If you want the power to instead remain on, see "Disabling the Automatic Power Saving function" on P20 and turn the function off.

Introduction

Thank you very much for purchasing a ZOOM **F8** Multitrack Field Recorder. The **F8** has the following features:

- **8 analog input channels with super high-quality preamps**
The 8 lockable XLR/TRS combo jacks provide high-quality analog inputs with EIN of -127 dBu or less, +75 dB maximum input gain and support for +4 dB input.
- **PCM recording at up to 192kHz/24-bit resolution**
- **Recording of up to 10 tracks simultaneously**
Inputs 1-8 and a stereo mix (left and right) can be recorded at the same time (8 tracks when the sampling rate is 192 kHz).
- **Dual channel recording of separate files at lower levels simultaneously with ordinary recording (Inputs 1-4)**
Using dual channel recording at a lower input level, you can create backup recordings to use when unexpected loud noise causes regular recordings to distort, for example.
- **Newly redesigned limiters for overload protection**
With 10 dB of headroom, this limiter prevents distortion even more than ordinary ones. The threshold can also be set to keep the signal below that level.
- **Time code with pinpoint accuracy**
The **F8** utilizes a high-precision oscillator that generates time-code with accuracy of 0.2ppm, ensuring rock-solid stability when syncing audio and video.
- **Outputs include a stereo headphone jack with a powerful 100mW amp as well as MAIN OUT 1/2 and SUB OUT 1/2 jacks**
This allows you to send the audio signal to a video camera or other device while monitoring with headphones.

- **Built-in digital mixer with flexible signal routing**
Prefader and postfader signals from inputs 1-8 can be freely routed to any outputs.
- **Phantom power (+24V/+48V) can be supplied**
This can be turned on/off for each input separately.
- **Three possible power sources—batteries, an AC adapter and an external DC power supply**
In addition to AA batteries and an AC adapter, a 9-16V external DC power supply can also be used.
- **Double SDXC card slots**
Simultaneous recording on 2 SD cards is possible, and support for SDXC cards up to 512 GB enables long-duration recording. In addition, the **F8** can be used as a card reader by connecting to a computer using USB.
- **USB audio interface capabilities with up to 8 ins and 4 outs**
The **F8** can be used not only as a 2-in/2-out audio interface, but also as an 8-in/4-out audio interface (driver required for Windows).
- **Other useful features**
Other convenient functions include a built-in slate mic for voice memos and a variable frequency slate tone generator to confirm levels. There are also input and output delays and pre-recording of up to 6 seconds.
- **ZOOM mic capsules can be connected**
Use any ZOOM mic capsule instead of inputs 1/2.

Please read this manual carefully to fully understand the functions of the **F8** so that you can make the most of it for many years. After reading this manual, please keep it with the warranty in a safe place.

Names of parts

Front

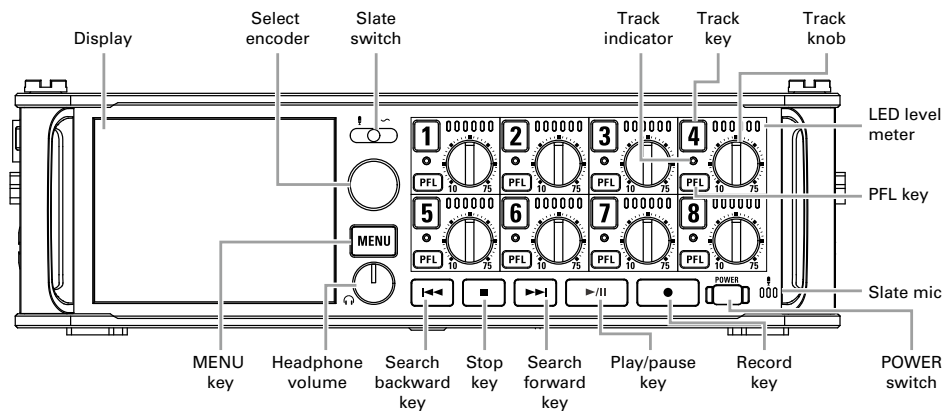

LED level meter

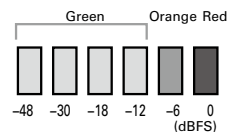

Back

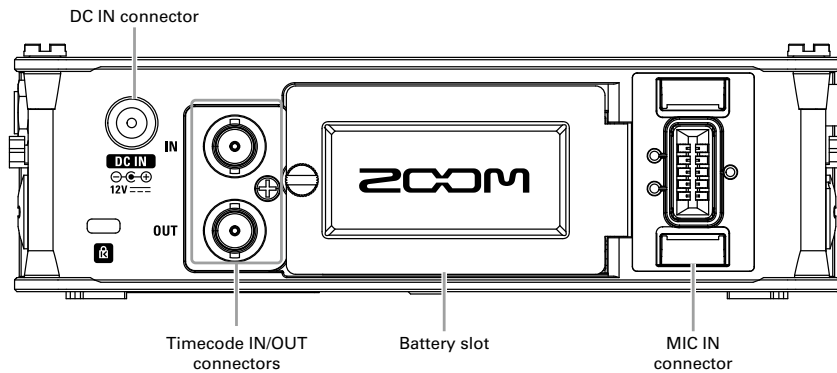

Left side

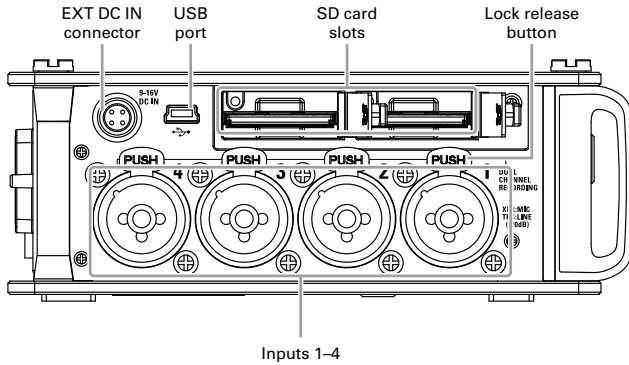

Right side

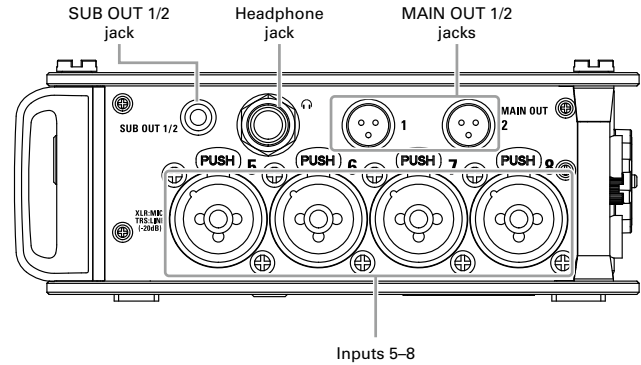

EXT DC IN

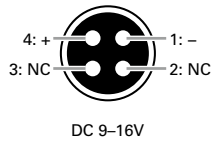

HIROSE 4-pin

Inputs 1-8

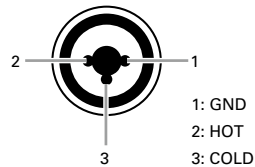

XLR

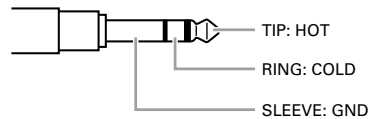

TRS

MAIN OUT

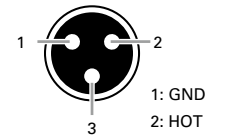

TA3

Connecting mics/other devices to Inputs 1–8

The **F8** can record a total of 10 tracks simultaneously: 8 individual tracks with signals coming from Inputs 1–8 and a stereo mix of these inputs on left and right tracks.

You can connect mics and the outputs of line-level devices such as keyboards, mixers, or instruments with active electronics to Inputs 1–8 and record them to tracks 1–8. Alternatively, Inputs 1 and 2 can instead receive input from a ZOOM mic capsule connected to the **F8** MIC IN connector.

Connecting mics

Connect dynamic and condenser mics with XLR plugs to Inputs 1–8.

Phantom power (+24V/+48V) can be supplied to condenser mics. (→ P.90)

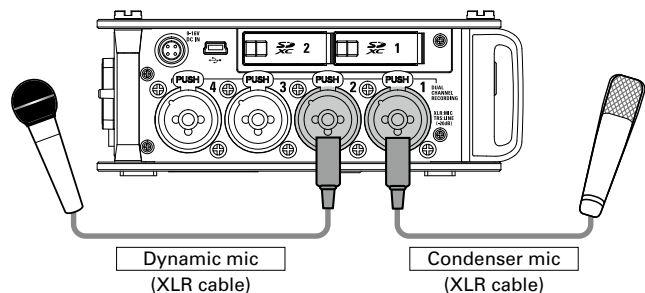

NOTE

When disconnecting a mic, gently pull on the XLR plug while simultaneously pushing the connector lock release button.

Connecting line level equipment

Connect the TRS plugs of keyboards and mixers directly to Inputs 1–8.

Direct input of passive guitars and basses is not supported. Connect these instruments through a mixer or effects device.

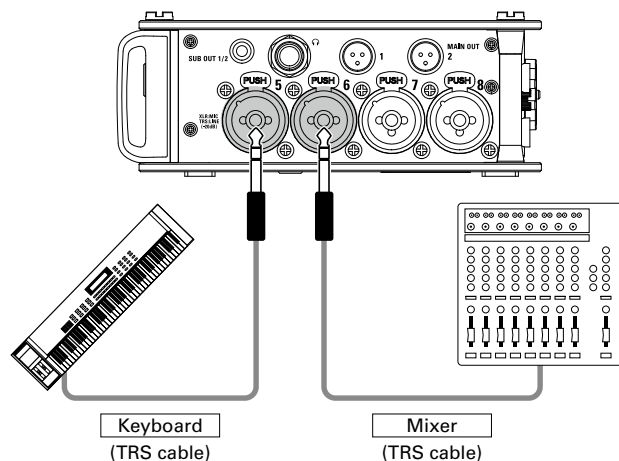

Connecting mic capsules

A ZOOM mic capsule can be connected to the MIC IN connector on the back of the **F8**.

NOTE

- The mic capsule input is assigned to tracks 1/2.
- When a mic capsule is connected, Inputs 1/2 cannot be used.

Connecting and disconnecting mic capsules

1. Remove the protective caps from the **F8** and the mic capsule or extension cable.

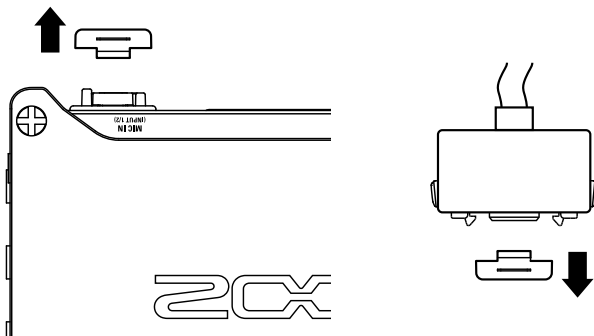

2. While pressing the side buttons on the mic capsule or extension cable, connect it to the main unit, inserting it completely.

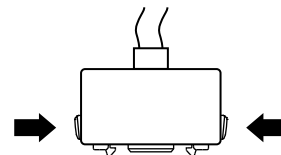

3. To disconnect the mic capsule or extension cable, pull it away from the main unit while simultaneously pressing the buttons on its sides.

NOTE

- Do not use too much force when disconnecting. Doing so could damage the mic capsule, extension cable or main unit.
- Reattach the protective cap when a mic capsule is not connected.

Stereo input

By enabling the stereo link for tracks 1/2, 3/4, 5/6 or 7/8, the corresponding Inputs (1/2, 3/4, 5/6 or 7/8) can be handled as a stereo pair. (→ P.27)

When linked, Input 1, 3, 5 or 7 becomes the left channel and Input 2, 4, 6 or 8 becomes the right channel.

Connecting mics/other devices to Inputs 1–8 (continued)

Connection examples

The **F8** allows you to record in a variety of situations, such as the following.

While filming

- Input 1: gun mic for main subject sound (XLR connection)
- Inputs 2–5: wireless lavalier mics for performers (TRS connections)
- Inputs 6–7: mics for ambient sound (XLR connections)

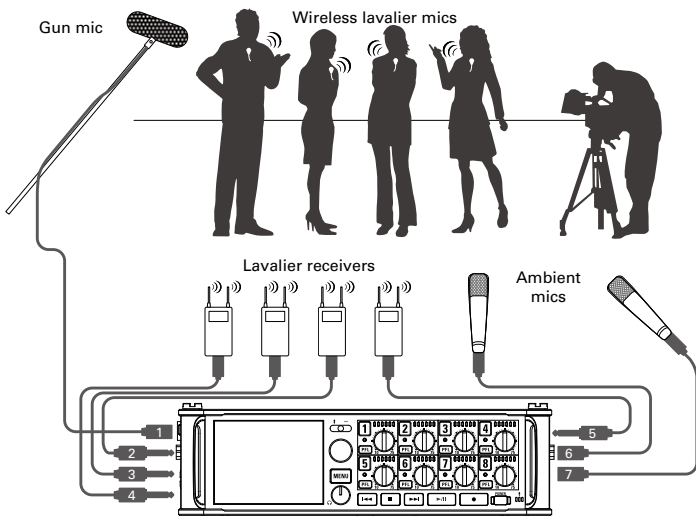

Concert recording

- Inputs 1-4: mics for stage performance (XLR connections)
- Inputs 5-6: line-level PA mixer outputs (TRS connections)
- Inputs 7-8: mics for audience sound (XLR connections)

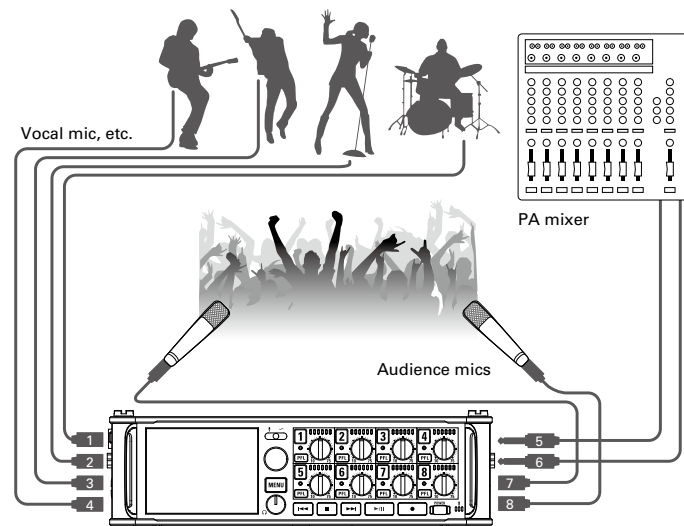

LCD display

Home Screen

Mixer

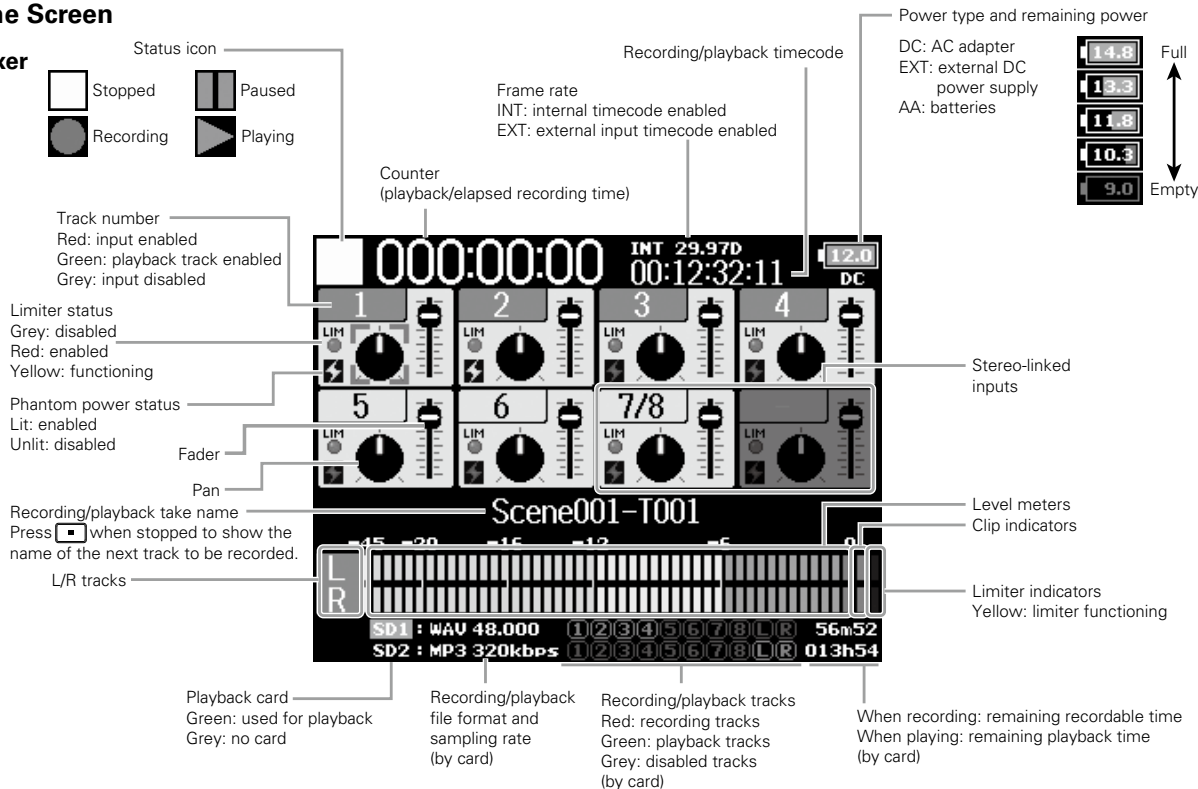
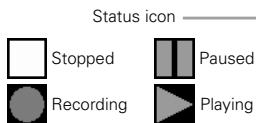

HINT

- Stereo-linked tracks are shown together, for example, "7/8".
- When the Home Screen is not displayed, press and hold to return to the Home Screen.

LCD display (continued)

Level meters

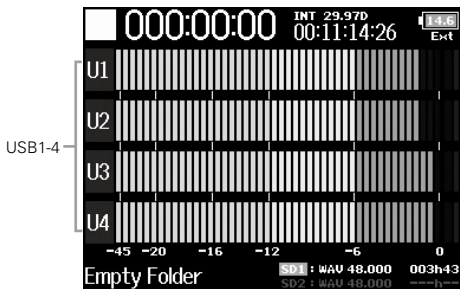
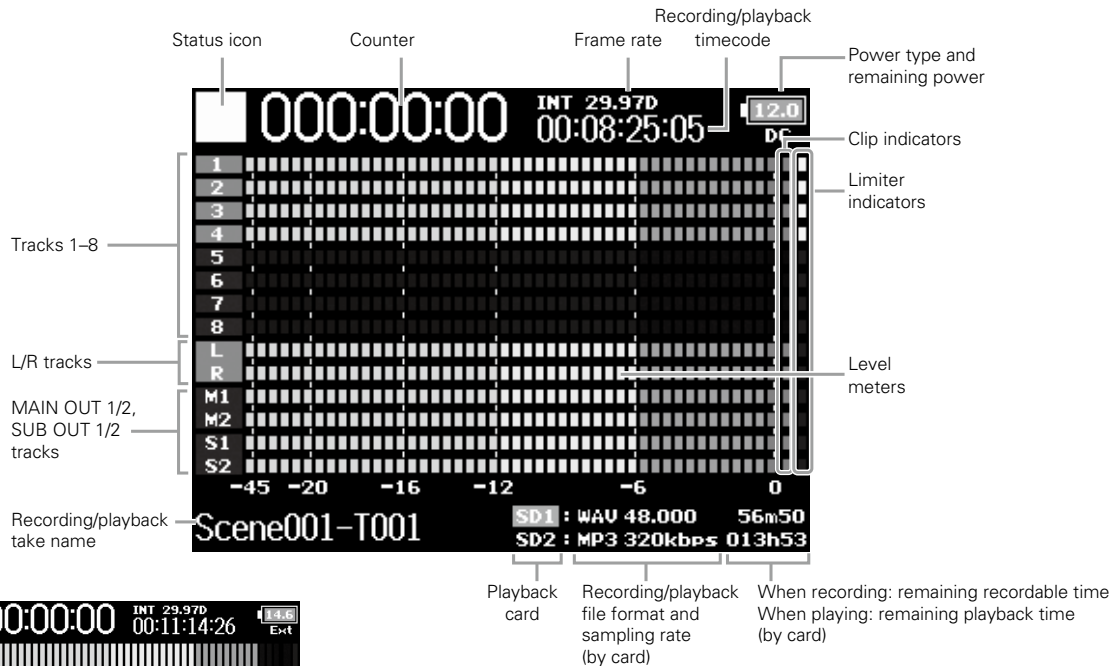

NOTE

Turn  to switch the mixer display (Tracks 1-8, MAIN OUT 1/2, SUB OUT 1/2, USB1-4) or level meter display (Views 1-4 can be set → P.163) shown on the LCD.

Character input screen

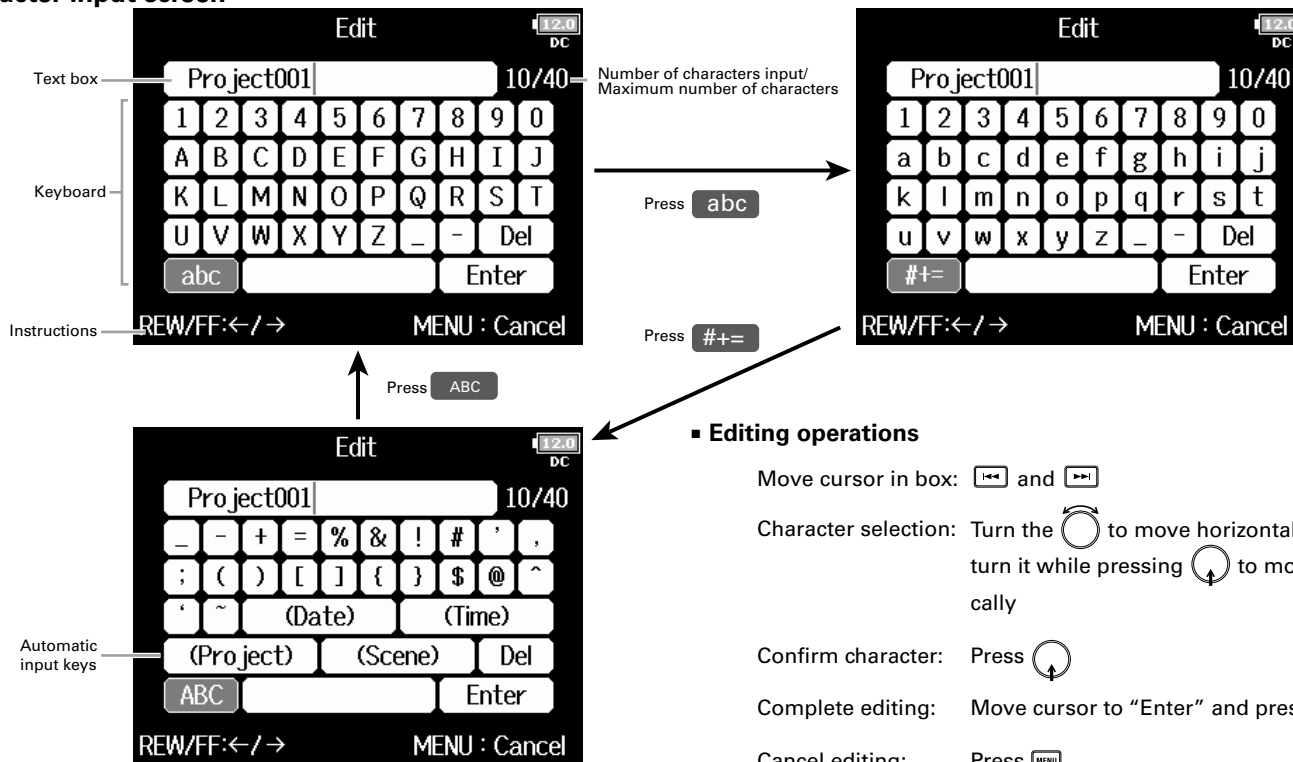

■ Editing operations

Move cursor in box: and

Character selection: Turn the to move horizontally and turn it while pressing to move vertically

Confirm character: Press

Complete editing: Move cursor to "Enter" and press

Cancel editing: Press

NOTE

- The following characters can be used in project names:
(space)!#\$'()+,-0123456789;=@ABCDEFGHIJKLMNQRSTU
VWXYZ[]^_`abcdefghijklmnopqrstuvwxyz~

HINT

- Press + to delete the previous character.
- Press + to move the cursor to "Enter".

LCD display (continued)

■ Automatic input keys

- (Date): Automatically inputs the date. Example: 150210
- (Time): Automatically inputs the time. Example: 180950
- (Project): Automatically inputs "Project***" in the field.
- (Scene): Automatically inputs the scene name.

Supplying power

Using AA batteries

1. Turn the power off and then loosen the screw in the battery cover to open it.

2. Remove the battery case from the battery slot.

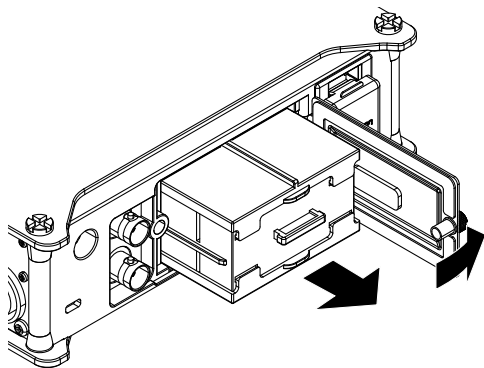

3. Open the battery case cover.

4. Install the batteries.

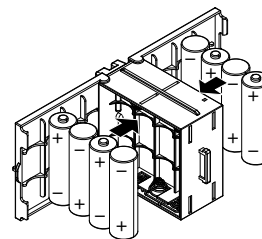

5. Replace the battery case cover.

6. Load the battery case.

NOTE

Load the case so that the side with the protruding rail is up.

7. Close the battery cover and tighten the screw.

NOTE

- Be careful because the battery case could become loose unexpectedly if the cover screw is not tightened firmly.
- Use only one type of batteries (alkaline, NiMH or lithium) at a time.
- After loading batteries, set "Power Source" to the correct type of battery. (→ P.22)
- If the remaining battery power indicator turns red, turn the power off immediately and install new batteries.

Supplying power (continued)

Using an AC adapter

1. Connect the dedicated AC adapter to the DC IN connector.

2. Plug the dedicated AC adapter into an outlet.

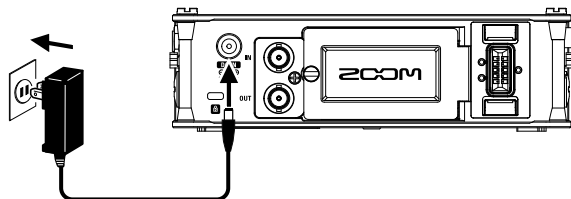

Using an external DC power supply

1. Connect the external DC power supply equipment to the EXT DC IN connector.

Connect a 9–16V direct-current power supply.

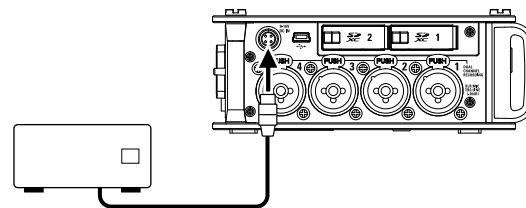

2. If there is an adapter, plug the adapter into an outlet.

NOTE

- When connecting an external DC power supply, be sure to make the power supply settings. (→ P.22)

Loading an SD card

1. Turn the power off and then open the SD card slot cover.

2. Insert the SD card into the SD CARD 1 or 2 slot.

To eject an SD card:

Push the card further into the slot until it clicks and then pull it out.

NOTE

- Always turn the power off before inserting or removing an SD card. Inserting or removing a card while the power is on could result in data loss.
- When inserting an SD card, be sure to insert the correct end with the top side up as shown.
- If an SD card is not loaded, recording and playback will not be possible.
- To format an SD card, see P. 176.

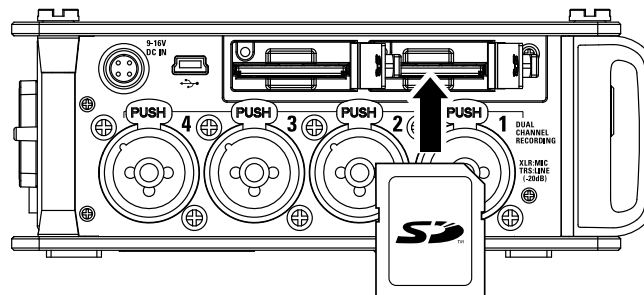

Turning the power on and off

Turning the power on

1. Press and hold  briefly.

The  LED will light.

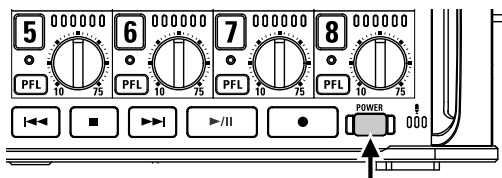

NOTE

- The first time you turn the power on after purchase, you must set the date/time (→ P. 19). You can also change this setting later.
- If "No Card!" appears on the display, confirm that an SD card is inserted properly.
- If "Card Protected!" appears on the display, the SD card write-protection is enabled. Slide the lock switch on the SD card to disable write-protection.
- If "Invalid Card!" appears on the display, the card is not formatted correctly. Format the card or use a different card. To format an SD card, see P. 176.

Turning the power off

1. Press and hold  briefly.

NOTE

Keep pressing it until the ZOOM logo appears on the LCD.



The **F8 will automatically turn off if it is unused for 10 hours.**

To keep the power on continuously until powered off, see "Disabling the Automatic Power Saving function" on P.21 and set Auto Power OFF to Off.

Setting the date and time (Date/Time (RTC))

The date and time set on the **F8** are used when recording files, for example. You can also set the date format (order of year, month and day).

1. Press .

2. Use  to select SYSTEM, and press .

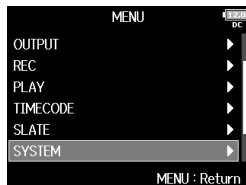

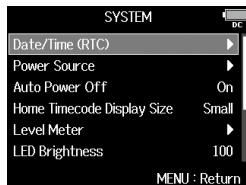

3. Use  to select Date/Time (RTC), and press .



► Continue to one of the following procedures.

Setting the date and time	P.19
Setting the date format	P.20

Setting the date and time

4. Use  to select Set Date/Time, and press .

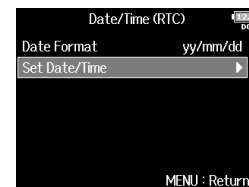

5. Change the setting.

▪ Changing settings

Move cursor or change value:



Turn 

Select item to change: Press 



The first time you turn the **F8** on after purchasing it, you must set the date/time.



Setting the date and time (Date/Time (RTC)) (continued)

- 6.** Use  to select Enter,
and press .



This completes setting the date and time.

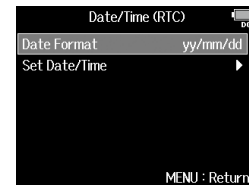

Setting the date format

- 4.** Use  to select Date
Format, and press .



- 5.** Use  to select the
format, and press .

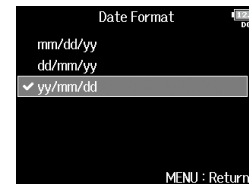



Setting value	Explanation
mm/dd/yy	Month, day, year order
dd/mm/yy	Day, month, year order
yy/mm/dd	Year, month, day order

Disabling the Automatic Power Saving function (Auto Power Off)



The power will automatically turn off if the **F8** is unused for 10 hours.

If you want the power to stay on continuously until powered off, disable the Automatic Power Saving function.

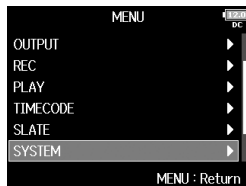

1. Press .

2. Use  to select SYSTEM,
and press .

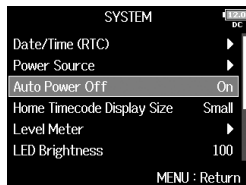

3. Use  to select Auto Power
Off and press .



4. Use  to select Off,
and press .

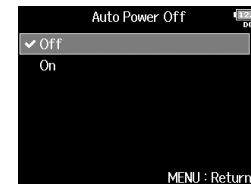



Setting the power supply used (Power Source)



Set the external DC power supply shutdown voltage, nominal voltage and type of batteries so that the remaining power supply charge can be shown accurately.

On this menu page, you can also check the voltage of each power supply and the remaining battery capacity.

1. Press .

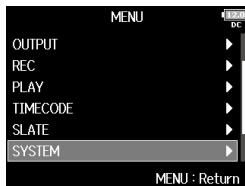
2. Use  to select SYSTEM,
and press .



3. Use  to select Power
Source, and press .

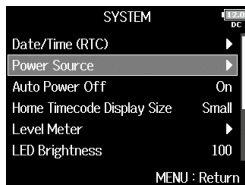



► Continue to one of the following procedures.

Setting the external DC power supply (Ext DC) shutdown voltage	P.22
Setting DC power supply (Ext DC) nominal voltage.	P.23
Setting the AA battery type (Int AA).	P.23

Setting the external DC power supply (Ext DC) shutdown voltage

When an external DC power supply is being used, if the voltage drops below the value set here, the **FS** will automatically stop recording and turn off.

If AA batteries (Int AA) are installed, however, the power supply will switch to Int AA and operation will continue.

4. Use  to select Shutdown
Voltage, and press .

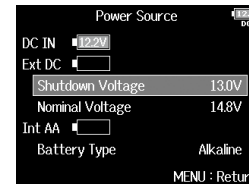



HINT

- The shutdown voltage is the voltage when the external DC power supply runs out and can no longer supply power.
- See the manual for the external DC power supply for the shutdown voltage value.

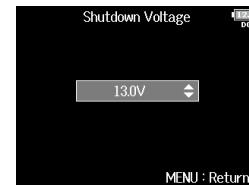

5. Use  to select the
voltage, and press .

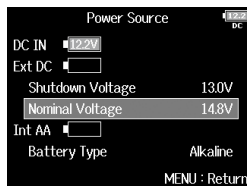

Setting DC power supply (Ext DC) nominal voltage

4. Use  to select Nominal Voltage, and press .



5. Use  to select the voltage, and press .

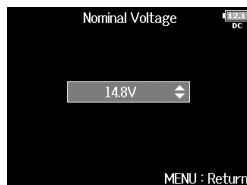



HINT

- The nominal voltage is the voltage of the external DC power supply under normal conditions. This value should be indicated on the outside of the external DC power supply.
- This can be set from 12.0 to 15.0 V in 0.2 V intervals.

Setting the AA battery type (Int AA)

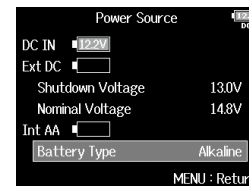
4. Use  to select Battery Type, and press .



5. Use  to select the type, and press .

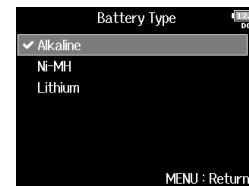

NOTE

- When multiple power supplies are connected, they will be used in the following order of precedence.
 1. Dedicated AC adapter (DC IN)
 2. External DC power supply (Ext DC)
 3. AA batteries in unit (Int AA)
- The voltages of each power supply are shown on the display.

Recording process

Recording with the **FB** follows the process shown below.
The data created for each recording occurrence is called a "take".

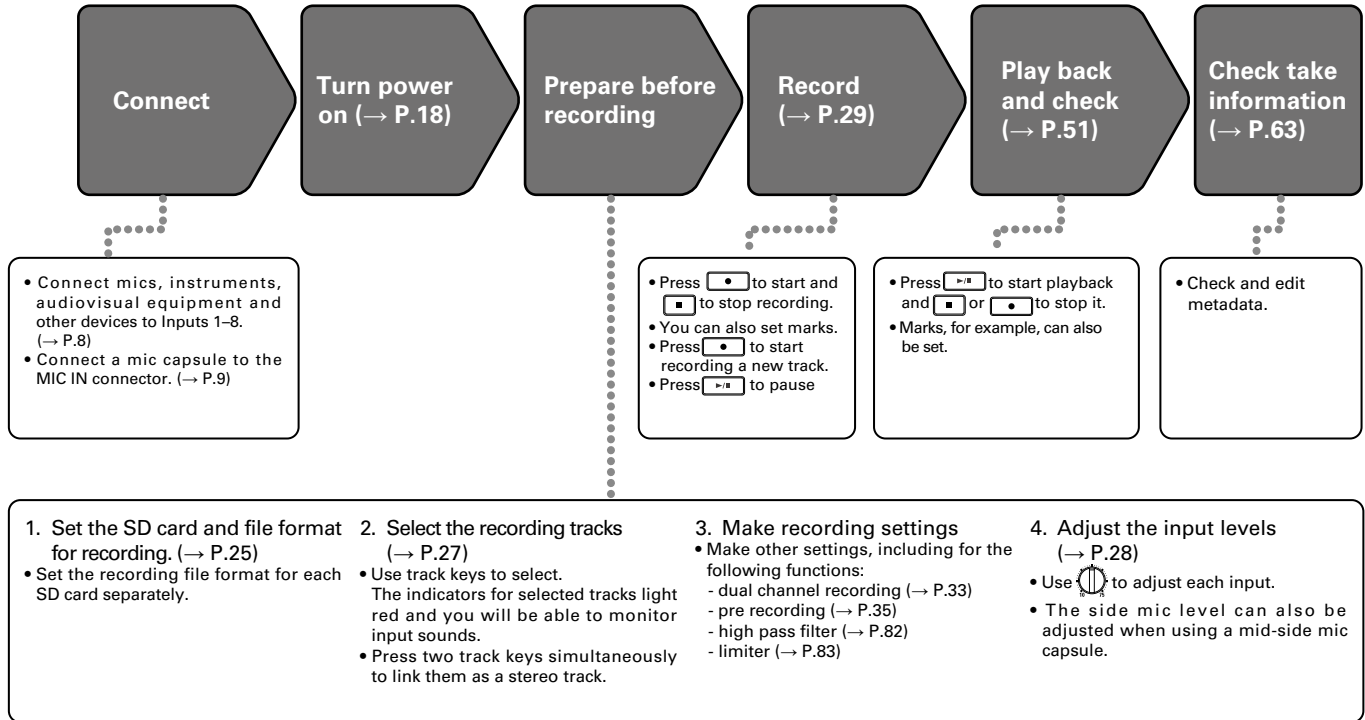



Enabling recording on SD cards and setting file formats

The recording file format can be set independently for SD CARD slots 1 and 2.



HINT

- Recording the same content to two cards is possible by using the same settings for both card slots. This function can be used to create a backup in case the sound skips on one card, for example.
- You can also record tracks 1–8 unmixed on one SD card while recording all tracks mixed together as MP3 or WAV data with left and right tracks.

1. Press .

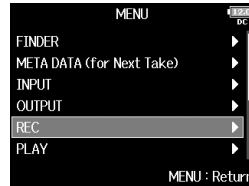
2. Use  to select REC, and press .



3. Use  to select Rec to SD1 or Rec to SD2, and press .

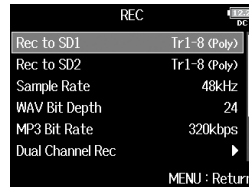

4. Use  to select the file type, and press .



Setting value	Tracks recorded	Explanation
None	–	Nothing is recorded on the SD card.
Track1-8 (Poly WAV)	Selected tracks 1–8	A single (multitrack) file is created that contains audio for multiple tracks.
Track1-8 (Mono/Stereo WAV)		A single mono file is created for each mono track and a single stereo file is created for each stereo track.
Track1-8 + L/R (Poly WAV)	All selected tracks	A single (multitrack) file is created that contains audio for multiple tracks.
Track1-8 + L/R (Mono/Stereo WAV)		A single mono file is created for each mono track and a single stereo file is created for each stereo track.
L/R (Stereo WAV)	L/R tracks	A stereo file is created based on the mix created by the internal mixer.
L/R (Stereo MP3)		

Enabling recording on SD cards and setting file formats (continued)

NOTE

- When recording with a Mono/Stereo WAV setting, the audio files are saved in a take folder that is created. (→ P.38)
- When recording to 2 SD cards simultaneously, files will be saved in take folders with the same name on both cards. Folders will be created automatically if they do not already exist.
- If recording should stop on one SD card because, for example, it runs out of space, recording will continue on the other SD card. At such times, do not remove the card that has stopped recording from the slot. Doing so could damage the card or data.

Selecting inputs and adjusting levels

You can select which of Inputs 1–8 to use. Inputs will be recorded on tracks with the same numbers. For example, Input 1 will be recorded on track 1 and Input 2 will be recorded on track 2.

Selecting inputs

1. Make the track indicator light by pressing the track key for the number of the input to record.

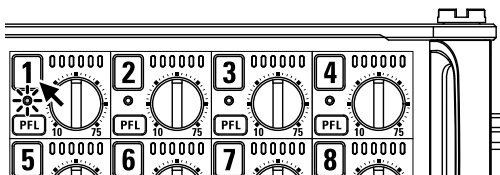

The background color of the track number on the LCD also changes at this time.

Track indicator	Track number background color	Explanation
Lit red	Red	The input is enabled.
Unlit	Gray	The input is disabled.

NOTE

The signals from the inputs selected this way will also be sent to the L/R tracks.

Linking inputs as a stereo pair

1. While pressing track key 1, press track key 2.

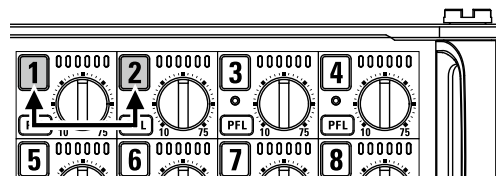

Tracks 1 and 2 will be linked as a stereo track (stereo link). Repeat the same procedure to disable the stereo link.

HINT

- The 3/4, 5/6 and 7/8 track pairs can also be stereo-linked in the same way.
- When a mic capsule that allows independent L and R input selection is connected, stereo-linking can also be enabled and disabled for those tracks.

Selecting inputs and adjusting levels (continued)

Adjusting input levels

1. Turn  for the selected track to adjust its input level.

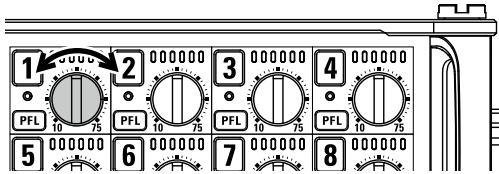

NOTE

When a mic capsule is connected,  for Inputs 1/2 is disabled. Use the level control on the mic capsule to adjust its input volume.

HINT

- Inputs connected with XLR plugs can be set from +10 to +75 dB, and inputs connected with TRS plugs can be set from -10 to +55 dB. Tracks with the USB set as the input source can be set from -35 to +30 dB.
- If the sound distorts even when you lower the input level, try changing mic positions and adjusting the output levels of connected devices.
- Using the limiter (→ P.83)
- Using the high pass filter (→ P.82)

Recording

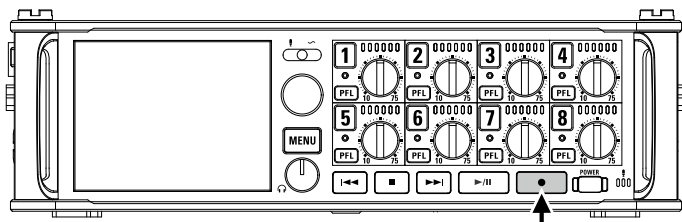

1. Press .

This starts recording.

HINT

If the timecode function is enabled, recording will start from frame 00 (00 or 02 when using drop frame) and files will always end exactly on a second. This makes synchronization easy when editing later.

2. Press  to start a new take when recording.

This will end the current take and start a new take while continuing to record without interruption.

NOTE



Pressing  during recording is only possible after recording for at least a second.

3. Press  to pause.

NOTE

- When pausing, pausing will occur at a whole second increment.
- When recording is paused, a mark is added at that point. Press  to resume recording.
- A maximum of 99 marks can be added to a take.

HINT

- During playback, you can press  and  to jump to points where marks have been added.
- You can also add marks without pausing. (→ P. 169)

4. Press  to stop.

NOTE

- If the maximum file size is exceeded during recording (→ P.36), recording will continue in a new take with a number that is one higher. No gap in sound will occur between the two takes when this happens.
- When recording on 2 SD cards simultaneously, if recording should stop on one because it runs out of space, recording will continue on the other SD card without interruption.



HINT

- Files are automatically saved at regular intervals during recording. Even if the power is interrupted or another unexpected problem occurs during recording, an affected file can be restored to normal by playing it with the **F8**.
- Press and hold  when the HOME screen is open to check the name that will be given to the next take recorded.



Setting the sampling rate (Sample Rate)

You can set the sampling rate used to record files.

1. Press .

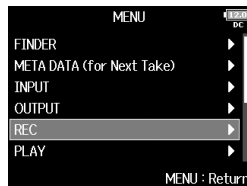
2. Use  to select REC,
and press .



3. Use  to select Sample
Rate, and press .

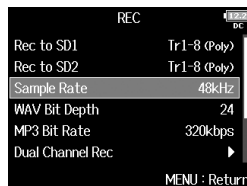

4. Use  to select the
sampling rate, and
press .

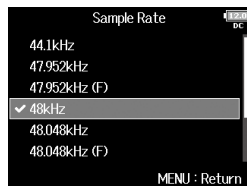

Setting value	Explanation
44.1kHz, 48kHz, 88.2kHz, 96kHz, 192kHz	These are standard sampling rates.
47.952kHz	Select this when recording video at 23.976 frames per second if you want to edit at 24 frames per second later.
48.048kHz	Select this when recording video at 24 frames per second if you want to edit at NTSC 29.97 or 23.98 HD later.
47.952kHz (F), 48.048kHz (F)	These function the same as the two above, but the <FILE_SAMPLE_RATE> sampling rate metadata will be recorded as 48kHz. This enables playback and editing with devices and software that do not support 47.952kHz and 48.048kHz WAV files. Playback, however, will occur at the $\pm 0.1\%$ speed at which the file was recorded.



NOTE

- When the recording file format is MP3, only 44.1kHz and 48kHz can be selected.
- When 192 kHz is selected, L/R tracks will not be recorded. The Input Delay and Output Delay are also disabled. Moreover, Auto Mix, Ambisonic Mode, and Input Limiter > On/Off > On (Advanced) cannot be set.
- Audio Interface with Rec cannot be used when values other than 44.1 kHz or 48 kHz are selected.



Setting WAV file bit depth (WAV Bit Depth)

You can set the bit depth of WAV files.

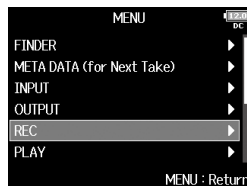

1. Press .

2. Use  to select REC,
and press .

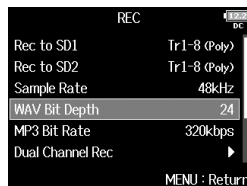

3. Use  to select WAV Bit
Depth, and press .



4. Use  to select the bit
depth, and press .





HINT

This can be set to 16-bit or 24-bit.

Setting MP3 file bit rate (MP3 Bit Rate)

You can set the bit rate of recorded MP3 files.

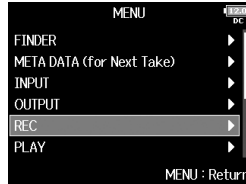

1. Press .

2. Use  to select REC,
and press .

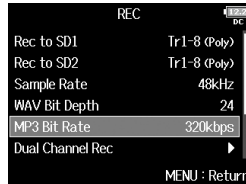

3. Use  to select MP3 Bit
Rate, and press .



4. Use  to select the bit
rate, and press .

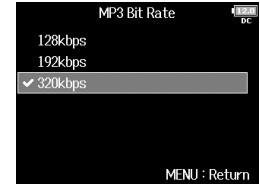



HINT

This can be set to 128 kbps, 192 kbps or 320 kbps.



Simultaneously recording tracks at different levels (Dual Channel Rec)

Along with regular recording, the **F8** can capture a second recording set to a different input level (dual channel recording). For example, by using dual channel recording to record at an input level 12 dB below that of the regular recording, you have an immediate replacement if the regular recording distorts because the track level is too high. Dual channel recording can be used with tracks 1–4.

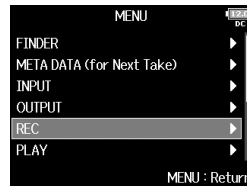

1. Press .

2. Use  to select REC,
and press .



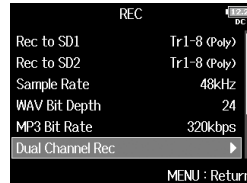

3. Use  to select Dual
Channel Rec, and press .

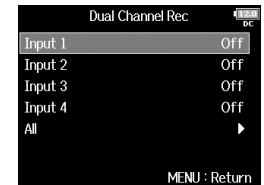

4. Use  to select the track,
and press .



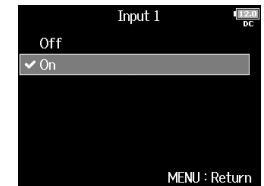

5. Use  to select On,
and press .



When dual channel recording is on, the name of the corresponding second track (5–8) changes.

Simultaneously recording tracks at different levels (Dual Channel Rec) (continued)

6. Turn  for the dual channel recording track to adjust the input level.

For example, when track 1 is selected, adjust  for track 5.



HINT

Dual channel recording increases the amount of space used on SD cards.



NOTE

- When using dual channel recording, the track that is numbered 4 higher than the original track is used for the second recording. For example, track 5 is used for the dual channel recording of track 1 and track 6 is used for track 2. Dual channel recording tracks cannot be used independently.
- When dual channel recording is enabled, if stereo-linking is enabled or disabled for tracks 1/2 or 3/4, the same setting will be applied to tracks 5/6 or 7/8.
- The limiter, high pass filter and other functions can be set independently for the regular and dual recording tracks.
- When a mic capsule is connected, its dual recording track input level is fixed at -12 dB compared to the regular track.



Capturing audio before recording starts (Pre Rec)

The input signal can be captured for up to 6 seconds before  is pressed (pre-recording). This is useful if, for example,  is pressed too late.

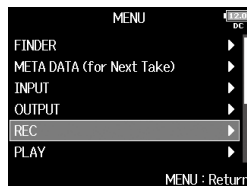

1. Press .

2. Use  to select REC,
and press .

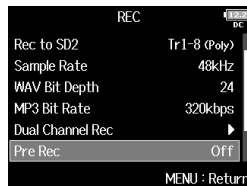

3. Use  to select Pre Rec,
and press .



4. Use  to select On,
and press .



File format	Sampling rate	Maximum pre-recording time
WAV	44.1kHz	6 seconds
	47.952kHz	6 seconds
	47.952kHz(F)	6 seconds
	48kHz	6 seconds
	48.048kHz	6 seconds
	48.048kHz(F)	6 seconds
	88.2kHz	3 seconds
	96kHz	3 seconds
MP3	192kHz	1 second
	44.1kHz	6 seconds
	48kHz	6 seconds



NOTE

Pre-recording will be disabled if MENU > TIMECODE > Timecode > Mode (→ P.126) is set to Int Record Run, Ext or Ext Auto Rec.



Maximum file size (File Max Size)

The maximum size of recording files can be set. If a recording file exceeds the maximum file size, recording will continue in a new take with a number that is one higher. No gap will occur in the sound between the two takes when this happens.

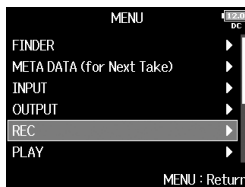

1. Press .

2. Use  to select REC,
and press .



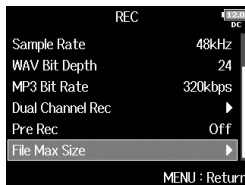

3. Use  to select File Max
Size, and press .

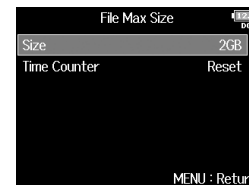

4. Use  to select Size,
and press .



5. Use  to select the
maximum size of recording
files, and press .





HINT

Setting the maximum size to 640MB or 512MB is convenient for backing up to CDs.

Showing total recording times for long recordings (Time Counter)

When recording for a long time, if the file size set with "File Max Size" is reached, recording will continue in a new take and the recording time will reset. You can change this, however, so that it is not reset and the total recording time is shown.

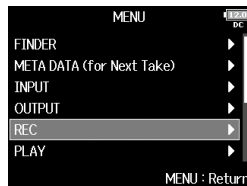

1. Press .

2. Use  to select REC,
and press .



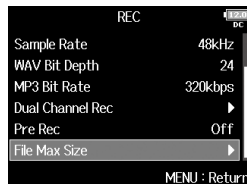

3. Use  to select File Max
Size, and press .



4. Use  to select Time
Counter, and press .



5. Use  to select
Continuous, and press .



Setting value	Explanation
Continuous	When recording, even if the file size set with "Size" is reached, the counter shown on the Home Screen will not be reset.
Reset	When recording, if the file size set with "Size" is reached, the counter shown on the Home Screen will be reset to 000:00:00.

Folder and file structure

When recording with the **FB**, folders and files are created on SD cards as shown below.

Folders and files are used to manage scenes and takes.

Folder and file structure

The folder and file structure differs according to the recording file format. In addition, the names of folders and files depend on how scenes are named.

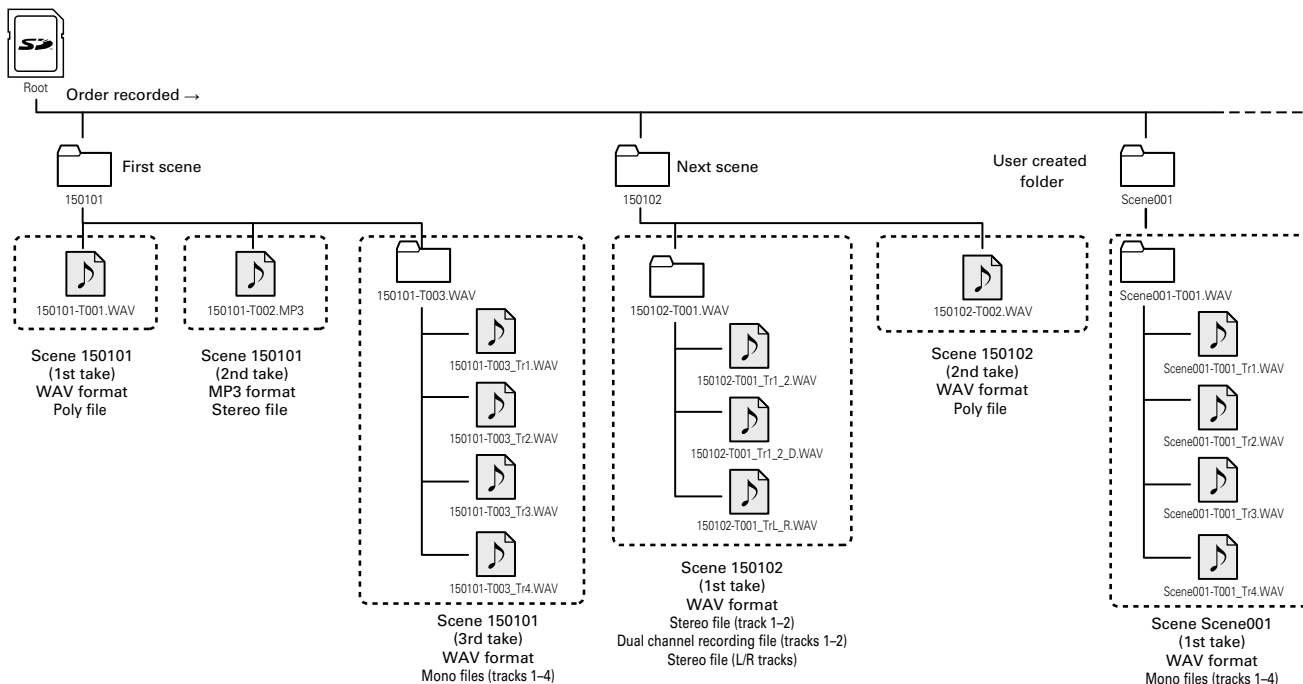

HINT

- A "take" is a unit of data created for a single recording.
- A "Scene" is a unit containing multiple files and takes that comprise a single scene.

NOTE

- Enabling recording on SD cards and setting file formats (→ P.25)
- Setting how scenes are named (mode) (→ P.43)

Take names

Structure	Explanation
Scene001-T001 	Scene name: Select none, the folder name, the date or a name input by the user (→ P.43). Scene number: Press + to advance the number by one. Take number: This number increases by 1 for each recording made with the same scene name and number.

Audio file names

File names are given by the **F8** according to the file format—poly, mono or stereo. Track numbers and other data are added to file names.

File names

File names are given according to the following formats.

Type	Structure	Explanation
Poly file	Scene001-T001.wav 	This is a file created by poly recording. Audio for multiple tracks is recorded to a single file.
Mono file	Scene001-T001_Tr1.wav 	This is a file created by mono recording.
Stereo file	Scene001-T001_Tr1_2.wav 	This is a file created by stereo recording.
Dual channel recording file	Scene001-T001_Tr1_D.wav 	This is a file created by dual channel recording.

HINT

When recording with a Mono/Stereo setting, the audio files are saved in the take folder that is created.

Moving the previously recorded take to the FALSE TAKE folder

If the just recorded take was a failure, you can use a shortcut to move the recording to the FALSE TAKE folder.

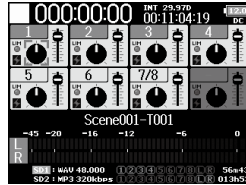

1. Open the Home Screen.



2. Press and hold .

HINT

- Moving the take recorded most recently to the FALSE TAKE folder will reduce the number of the take recorded next by 1.
- Even during recording, you can move the previously recorded take to the FALSE TAKE folder.

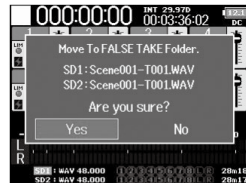

3. Use  to select Yes,
and press .





Changing the note for the next take recorded (Note)

You can input characters for a note to use as metadata in the file.

1. Press .

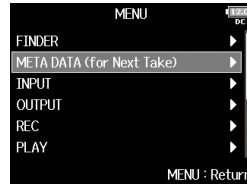
2. Use  to select META
DATA (for Next Take),
and press .



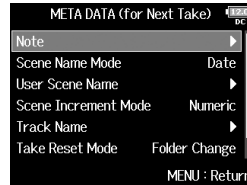

3. Use  to select Note,
and press .



► Continue to one of the following procedures.

Editing notes	P.41
Selecting notes from the history list	P.42

Editing notes

4. Use  to select Edit,
and press .

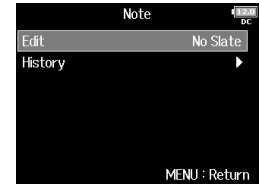

5. Edit the note.
See "Character input screen"
(→ P.13) for how to input
characters.





NOTE



This note is written to the <NOTE> metadata.

Changing the note for the next take recorded (Note) (continued)

Selecting notes from the history list

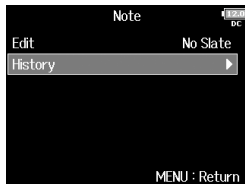
- 4.** Use  to select History,
and press .



- 5.** Use  to select the item
to use, and press .

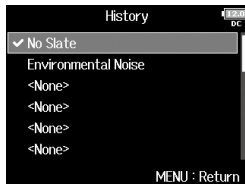



NOTE

The history list will be erased if the Factory Reset function is used.

Setting how recorded scenes are named and numbered

You can set how scenes are named (name mode), the base scene name and how scene numbers advance.

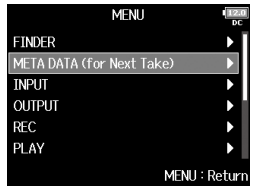

1. Press .

2. Use  to select META DATA (for Next Take), and press .





- ▶ Continue to one of the following procedures.
- Setting how scenes are named (mode) P.43
- Changing scene names P.44
- Selecting a scene name from the history list P.45
- Setting how scene numbers advance P.45

Setting how scenes are named (mode)

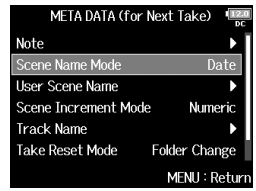
3. Use  to select Scene Name Mode, and press .



4. Use  to select the mode, and press .

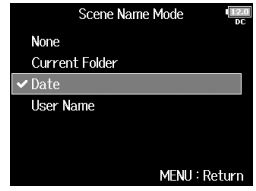

Setting how recorded scenes are named and numbered (continued)

Setting value	Explanation
None	The scene name and number are not used. When recording files are created, they are named only with the take number, such as "T001", "T002", "T003" and so on. + cannot be used to advance the scene number by 1. Example: T001.wav
Current Folder	The name of the currently selected folder is used as the scene name. + can be used to advance the scene number by 1. After advancing the scene number by 1, the corresponding folder will be used as the recording destination. If that folder does not already exist, it will be created. Example: FOLDER001-T001.wav
Date	The date is used as the scene name. + cannot be used to advance the scene number by 1. If recording occurs after the date changes, a scene folder with the date will be created. Example: 20150101-T001.wav
User Name	A scene name input by the user is used. + can be used to advance the scene number by 1. No folder is created in this case. Example: MYSCENE001-T001.wav

Changing scene names

If Scene Name Mode is set to User Name, set the scene name used like this.

3. Use to select User Scene Name, and press .

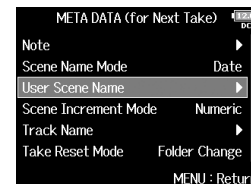

4. Use to select Edit, and press .

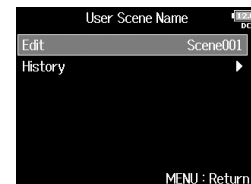

5. Edit the scene name.



See "Character input screen" (→ P.13) for how to input characters.





NOTE

The scene name is written to the <SCENE> metadata.
You cannot put a space or an @ mark at the beginning of the name.

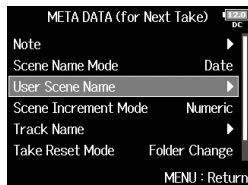

Selecting a scene name from the history list

3. Use  to select User Scene Name, and press .

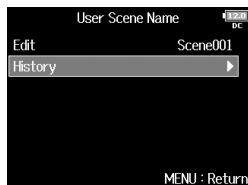

4. Use  to select History, and press .





5. Use  to select the item to use, and press .





NOTE

The history list will be erased if the Factory Reset function is used.



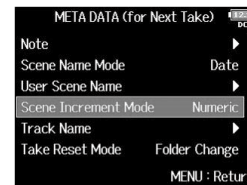

Setting how scene numbers advance

3. Use  to select Scene Increment Mode, and press .

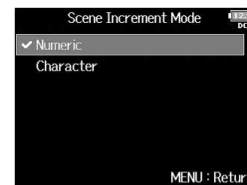

4. Use  to select how scene numbers advance, and press .





Setting value	Explanation
Numeric	Press  +  on the Home Screen to increase the scene number by one. Example: Scene → Scene1 → Scene2 → ... → Scene9999
Character	Press  +  on the Home Screen to advance the capital letter at the end of the scene name by one. If the scene name does not have a capital letter at its end, one will be added. Example: Scene1 → Scene1A → Scene1B → ... → Scene1Z → Scene1AA → Scene1AB → ...

Setting the take name reset condition and format

You can set the take name reset condition and format used when recording.

1. Press .

2. Use  to select META DATA (for Next Take), and press .

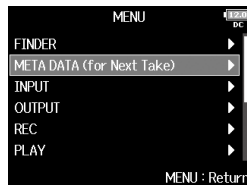



▶ Continue to one of the following procedures.



Setting the take name reset condition. P.46

Setting the take name format. P.47

Setting the take name reset condition

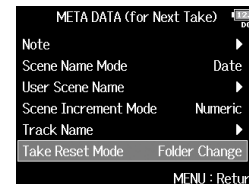
3. Use  to select Take Reset Mode, and press .



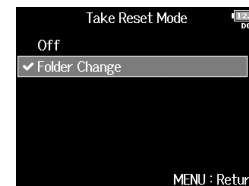

4. Use  to select the reset mode, and press .





Setting value	Explanation
Off	The take number will not be reset. However, if the folder is changed and that folder contains a number higher than the current take number, the take number will be set to one higher than the highest existing take number.
Folder Change	If the destination folder is changed, the take number will be set to one higher than the highest take number in that folder.

Setting the take name format

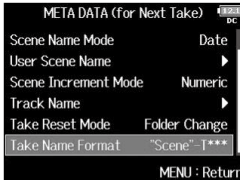
3. Use  to select Take Name Format, and press .



4. Use  to select the format, and press .





Setting value	Explanation
"Scene"-T***	<p><u>"Scene"-T***</u></p> <p>└─ Take name</p> <p>└─ Scene name</p> <p>Example: Scene001-T001</p>
"Scene"_***	<p><u>"Scene"_***</u></p> <p>└─ Take name</p> <p>└─ Scene name</p> <p>Example: Scene001_001</p>



Changing the track name of the next take recorded (Track Name)

The track name set with the following procedure will be given to the next recorded track.

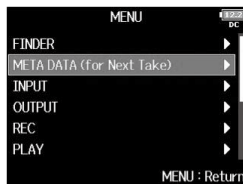

1. Press .

2. Use  to select META
DATA (for Next Take),
and press .

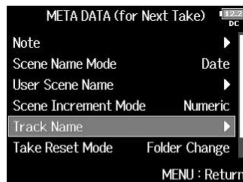

3. Use  to select Track
Name, and press .



4. Use  to select the track,
and press .

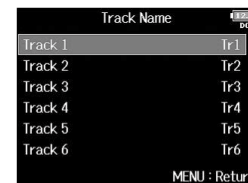



► Continue to one of the following procedures.



Editing the track name P.49

Selecting a track name from the History list P.49

HINT

On the Home Screen,  +  can be used to open the Track Name screen.

Editing the track name

5. Use  to select Edit,
and press .



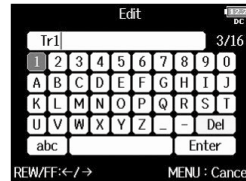

6. Edit the track name.

See "Character input screen"
(→ P.13) for how to input
characters.



**NOTE**

The track name is written to the <TRACK> <NAME> metadata.

Selecting a track name from the history list

5. Use  to select History,
and press .



6. Use  to select the item
to use, and press .

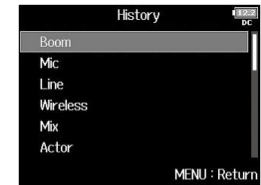

**NOTE**

The history list will be erased if the Factory Reset function is used.

Changing the number of the next take recorded

The number given to the next recorded take can be changed when the Home Screen is open.

1. Press and hold .

2. Use  to increase or decrease the take number by one, and press .



NOTE

This function cannot be used during recording and playback or when the scene naming method (Scene Name Mode) is set to Date. You can change how scenes are named with the following menu item.

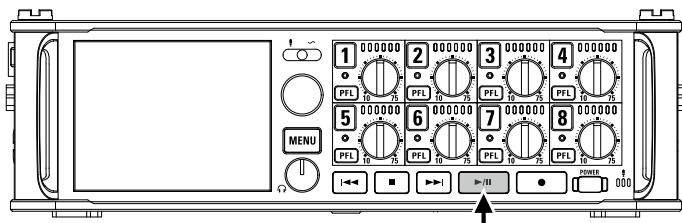

MENU > META DATA (for Next Take) > Scene Name Mode

Playing recordings



1. Press .

■ Playback operations

Select take or jump to mark: Press  or 

Search backward/forward: Press and hold  / 



Pause/resume playback: Press 

NOTE

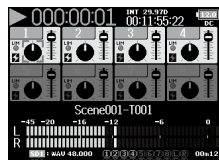
Tracks that have no playback files appear gray.



HINT

- The longer you press and hold  / , the faster the backward/forward search speed.
- During playback, press track keys to switch between playing back (lit green) and muted (unlit).
- An "Invalid Take!" message will appear if the selected take is not valid.
- A "No Take!" message will appear if no take exists.
- During playback, you can press  to add a mark that can be used for skipping. (→ P. 170)

2. Press to return to the Home Screen.



Mixing takes

You can change the volume and panning of each track during playback.

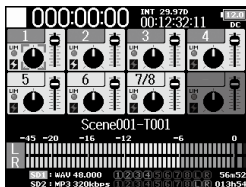
1. Open the mixer on the Home Screen. (→ P.11)



HINT

- You can turn  to move the cursor, and also adjust the settings of the MAIN OUT 1/2 and SUB OUT 1/2 tracks (→ P.116).
- When a fader or pan knob is selected, press and hold  to reset it to its default value. If already set to its default value, selecting a fader mutes the track.

2. Press  to start playback.

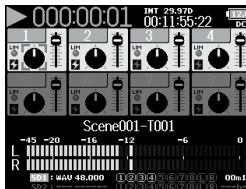

NOTE

- Settings are saved separately for each take and are used during playback.
- Mix settings are not saved with the take when the format is MP3.

3. Adjust the parameter settings.

See "Adjusting the input signal monitoring balance" (→ P.75) for how to change settings.

Monitoring the playback signals of specific tracks during playback

You can monitor the playback signals of specific tracks using SOLO mode.

1. Open the Home Screen.

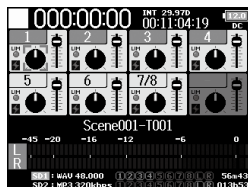

2. Press  to start playback.

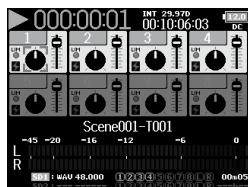

3. Press  on the tracks that you want to monitor.

The background colors for the selected tracks will become green, and their track indicators will light orange.

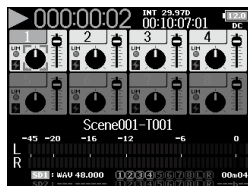

NOTE



SOLO mode can only be used with tracks that can be played back (indicators lit green).

4. Press  of a track being monitored to stop monitoring it.



Changing the playback mode (Play Mode)

You can change the playback mode.

1. Press .

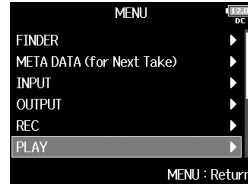
2. Use  to select **PLAY**,
and press .



3. Use  to select **Play Mode**,
and press .



4. Use  to select the play
mode, and press .





Setting value	Explanation
Play One (single playback)	Only the selected take will be played.
Play All (all playback)	Takes will be played back continuously from the selected one until the last take.
Repeat One (single repeat playback)	The selected take will be played repeatedly.
Repeat All (all repeat playback)	All takes in the selected folder will be played repeatedly.

Take and folder operations (FINDER)

The FINDER allows you to select and view the contents of SD cards, takes and folders, and to create project/scene folders. It also allows you to, for example, set and delete recording/playback folders and view their information.

1. Press **MENU**.

2. Use  to select FINDER, and press .

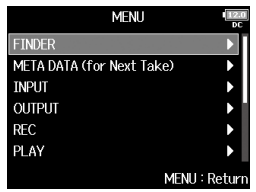

3. Turn  to select the SD card, folder or take that you want to use.

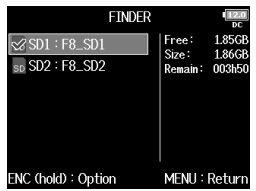

▪ SD card selected

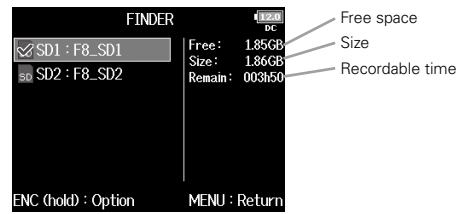

▪ Folder selected

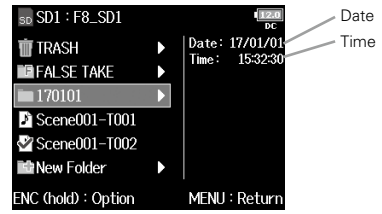

▪ Take selected

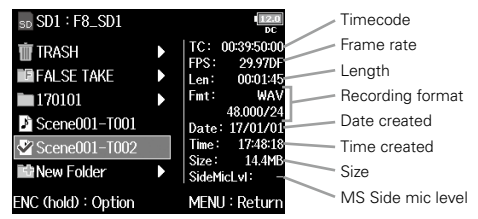

▪ Editing operations





Move cursor: Turn 

Move down a level: Press 

Move up a level: Press **MENU**

Take and folder operations (FINDER) (continued)

NOTE



- When the cursor is on a take, you can press  to play the selected take. You can also use ,  and .
- A check mark appears on the playback take and recording/playback folder.

- Continue to one of the following procedures.

Creating folders.....	P.56
Selecting the take recording/playback folder.....	P.57
Checking take marks and using them for playback	P.57
Changing folder and take names	P.58
Copying takes to other cards and folders	P.58
Deleting folders and takes	P.59
Emptying the TRASH/FALSE TAKE folder.....	P.60

Creating folders

Folders can be created inside the currently selected SD card/folder.

- 4.** Use  to select New Folder, and press .



- 5.** Edit the folder name.

See "Character input screen" (→ P.13) for how to input characters.





NOTE

- The folder created will be set as the recording folder.
- The name of the folder created is written to the <PROJECT> or <SCENE> metadata.
- You cannot put a space or an @ mark at the beginning of the name.

Selecting the take recording/playback folder

Use this procedure to select the folder that contains the take to be played or the folder to use for recording takes.

- 4.** Press and hold ,
use  to select Select,
and press .

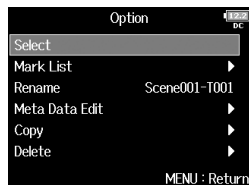



NOTE

- The first take inside the selected SD card or folder will be set as the playback take.
- After selecting the take recording/playback folder, the Home Screen will reopen.

Checking take marks and using them for playback

You can view a list of the marks in a recorded take.

- 4.** Press and hold ,
use  to select Mark List,
and press .

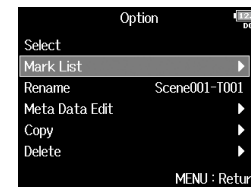

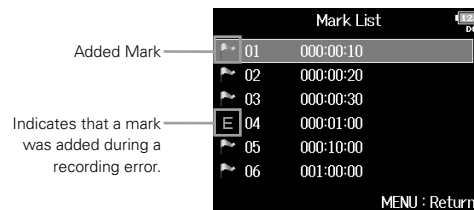

- 5.** Use  to select a mark, and press .

The Home Screen will reopen, and playback will start from the mark.





Take and folder operations (FINDER) (continued)

Changing folder and take names

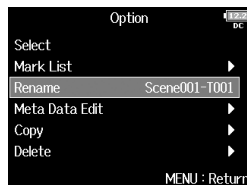
- 4.** Press and hold ,
use  to select Rename,
and press .



Copying takes to other cards and folders

- 4.** Press and hold ,
use  to select Copy,
and press .

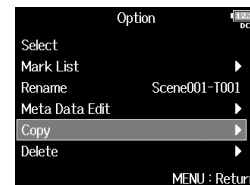

- 5.** Edit the folder/take name.

See "Character input screen"
(→ P.13) for how to input
characters.

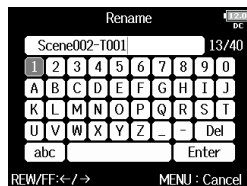

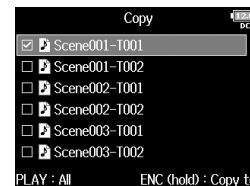

- 5.** Use  to select the take to
copy, and press .



NOTE



- The edited name of the folder/take is written to the <PROJECT> or <SCENE> metadata.
- You cannot put a space or an @ mark at the beginning of the name.

- 6.** Press and hold .

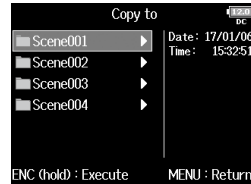

- 7.** Use  to select the copy destination, and press and hold .

**NOTE**

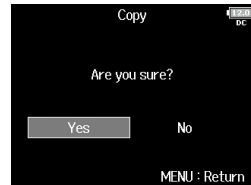

See "Take and folder operations" for how to select a folder. (→ P.55)

- 8.** Use  to select Yes, and press .

**Deleting folders and takes**

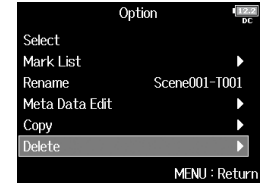
- 4.** Press and hold , use  to select Delete, and press .



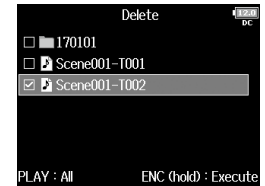

- 5.** Use  to select the folder/take to delete, and press . Press  to cancel deletion.

**NOTE**

You can press  to select/deselect all the folders and takes that are currently shown.

- 6.** Press and hold .

Take and folder operations (FINDER) (continued)

- 7.** Use  to select Yes,
and press .

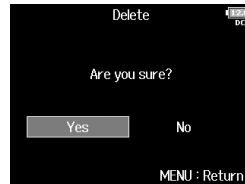

NOTE

- Deleted folders and takes are not immediately erased from the SD card. They are moved to the TRASH folder.
- Deleting the folders and takes in the TRASH folder will completely erase their data.

Emptying the TRASH/FALSE TAKE folder

- 4.** Use  to select TRASH
or FALSE TAKE.

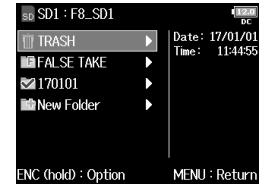

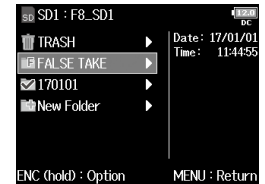

TRASH folder





FALSETAKE folder

- 5.** Press and hold .

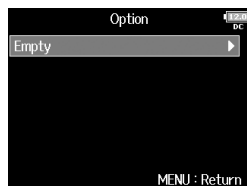
- 6.** Use  to select Empty,
and press .

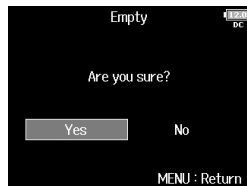

- 7.** Use  to select Yes,
and press .

**NOTE**

- Emptying the TRASH folder will completely erase the data in it.
- Emptying the FALSE TAKE folder will not immediately erase the data in it from the SD card. Instead, this data will be moved to the TRASH folder.

Overview of take information (metadata) stored in files

The **FB** writes a variety of information (metadata) to files during recording.

When these files are read by an application that supports metadata, you will be able to check and use the saved information.

HINT

- Metadata is data that contains information related to other data.
The **FB** saves scene names and take numbers, for example, as metadata in audio files.
- A chunk is a unit that contains multiple data in a single block.
- To use BEXT and iXML chunk metadata, an application that supports both data formats is necessary.

WAV file metadata

The metadata saved in files recorded by the **FB** in WAV format is collected in BEXT (Broadcast Audio Extension) and iXML chunks.

For information about the metadata saved in these chunks, see the "Metadata contained in BEXT chunks in WAV files" (→ P.186) and "Metadata contained in iXML chunks in WAV files" (→ P.187).

MP3 file metadata

The metadata saved in files recorded by the **FB** in MP3 format is written as ID3v1 tags.



For information about the ID3 fields and formats for saving metadata, see the "Metadata and ID3 fields contained in MP3 files" (→ P.189).

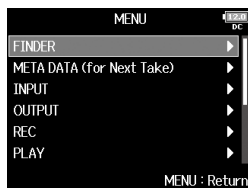

HINT

- **FB** MP3 files conform to the MPEG-1 Layer III standard.
- MP3 metadata cannot be edited.

1. Press .





2. Use  to select FINDER, and press .

3. Use  to select the take, and press .

This opens the Option Screen. See “Take and folder operations” for how to use the Finder. (→ P.55)



4. Use  to select Meta Data Edit, and press .

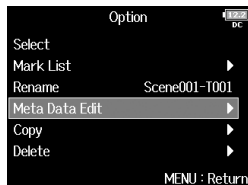



► Continue to one of the following procedures.



Checking and editing notes	P.64
Selecting notes from the history list	P.64
Checking and editing scene names	P.65
Selecting a scene name from the history list	P.65
Checking and editing take names	P.66
Circling takes	P.67
Editing folder (tape) names	P.67
Editing project names	P.68
Checking and editing track names	P.68
Selecting a track name from the History list	P.69

Checking and editing take metadata

Checking and editing notes

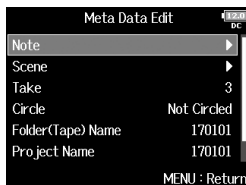
- 5.** Use  to select Note,
and press .



- 6.** Use  to select Edit,
and press .

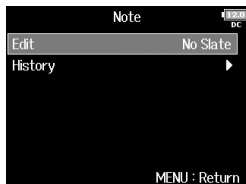



- 7.** Edit the note.



See "Character input screen"
(→ P.13) for how to input
characters.



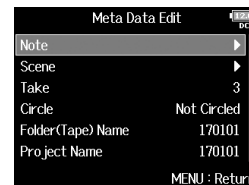

Selecting notes from the history list

- 5.** Use  to select Note,
and press .

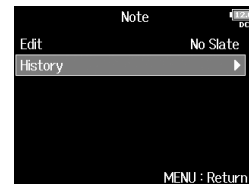

- 6.** Use  to select History,
and press .



- 7.** Use  to select the item
to use, and press .

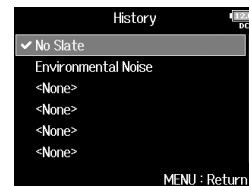



NOTE

The content of this note is written to the <NOTE> metadata.



NOTE

The history list will be erased if the Factory Reset function is used.

Checking and editing scene names

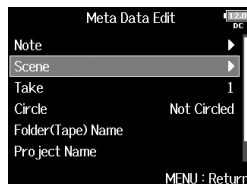
- 5.** Use  to select Scene,
and press .



- 6.** Use  to select Edit,
and press .

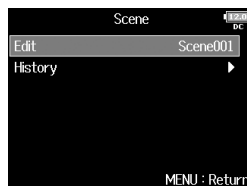



- 7.** Edit the scene name.
See "Character input screen"
(→ P.13) for how to input
characters.





NOTE

The scene name is written to the <SCENE> metadata.

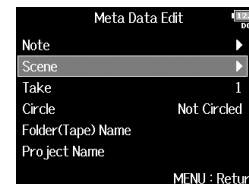

Selecting a scene name from the history list

- 5.** Use  to select Scene,
and press .

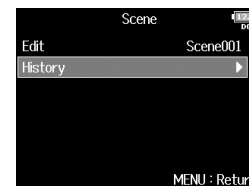

- 6.** Use  to select History,
and press .



- 7.** Use  to select the item
to use, and press .





NOTE



The history list will be erased if the Factory Reset function is used.

Checking and editing take metadata (continued)

Checking and editing take names

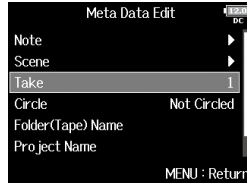
- 5.** Use  to select Take,
and press .



- 7.** When done changing,
use  to select Enter,
and press .



- 6.** Change the take number.



- Editing operations

Move cursor or change value: Turn 

Select parameter to change: Press 

HINT



This can be set from 1 to 999.

NOTE



The take number is written to the <TAKE> metadata.

Circling takes

Use this function to add an @ mark to the beginning of the name of the best take to make it stand out. This is called a "circled take".

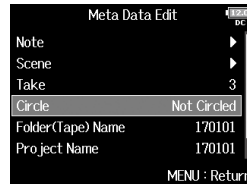
- 5.** Use  to select Circle, and press .



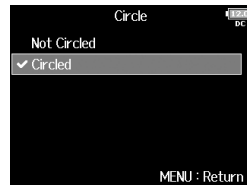

- 6.** Use  to select Circled, and press .



NOTE

- To clear a circle, select Not Circled and press .
- This circled status is written to the <CIRCLE> metadata.

Editing folder (tape) names

- 5.** Use  to select Folder (Tape) Name, and press .

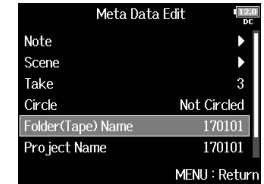

- 6.** Edit the folder (tape) name.

See "Character input screen" (→ P.13) for how to input characters.



NOTE

- The folder (tape) name is written to the <TAPE> metadata.
- The folder (tape) name used immediately after recording is the name of the folder in which the take was recorded.
- You cannot put a space or an @ mark at the beginning of the name.

Checking and editing take metadata (continued)

Editing project names

- 5.** Use  to select Project Name, and press .

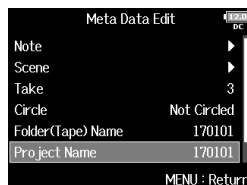

- 6.** Edit the project name.

See "Character input screen" (→ P.13) for how to input characters.





NOTE

- The project name is written to the <PROJECT> metadata.
- The project name used immediately after recording includes the name of the highest level folder (inside the SD card root directory) that contains the folder in which the take was recorded.
- You cannot put a space or an @ mark at the beginning of the name.

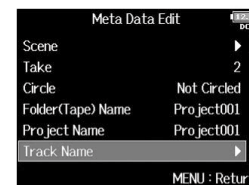

Checking and editing track names

- 5.** Use  to select Track Name, and press .

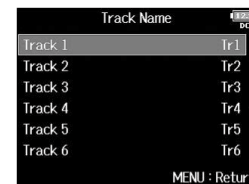

- 6.** Use  to select the track, and press .



- 7.** Use  to select Edit, and press .





8. Edit the track name.

See "Character input screen"
(→ P.13) for how to input
characters.



**NOTE**

The track name is written to the <TRACK> <NAME> metadata.

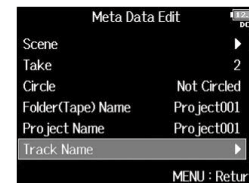

Selecting a track name from the history list

- 5.** Use  to select Track
Name, and press .



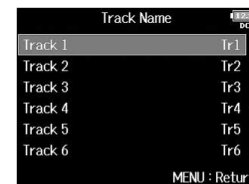

- 6.** Use  to select the track,
and press .



- 7.** Use  to select History,
and press .



Checking and editing take metadata (continued)

- 8.** Use  to select the item
to use, and press .



NOTE



The history list will be erased if the Factory Reset function is used.

Writing sound reports (Create Sound Report)



A sound report includes information about recording times and takes.

Reports can be written as CSV format files (F8_[folder name].CSV). You can edit the comments written in sound reports.

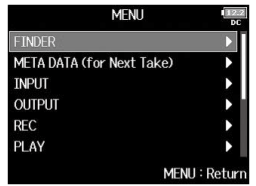

1. Press .

2. Use  to select FINDER, and press .

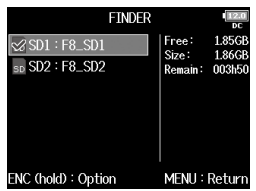

3. Use  to select the folder or SD card for which you want to create a sound report, and press and hold .



4. Use  to select Create Sound Report, and press .

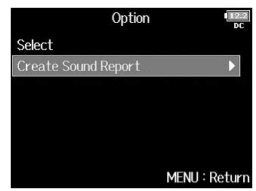



► Continue to one of the following procedures.



Writing a sound report	P. 72
Editing comments	P. 72
Selecting comments from the history list	P. 73

Writing sound reports (Create Sound Report) (continued)

Writing a sound report

- 5.** Use  to select Create, and press .



- 6.** Use  to select Yes, and press .

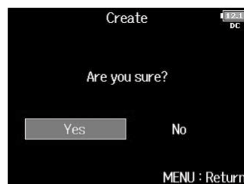



This writes the sound report inside the selected SD card or folder.



NOTE

- Only information about takes in the folder or SD card is written in the sound report.
- If a sound report file with the same name already exists, it will be overwritten. Please use caution.



Editing comments

- 5.** Use  to select Info Edit, and press .



- 6.** Use  to select Comments, and press .



- 7.** Use  to select Edit, and press .





- 8.** Edit the comment.



See "Character input screen" (→ P.13) for how to input characters.





Selecting comments from the history list

5. Use  to select Info Edit,
and press .





6. Use  to select Comments,
and press .



7. Use  to select History,
and press .



8. Use  to select the item
to use, and press .



HINT
The history list will be erased if the Factory Reset function is used.

Input and output signal flow

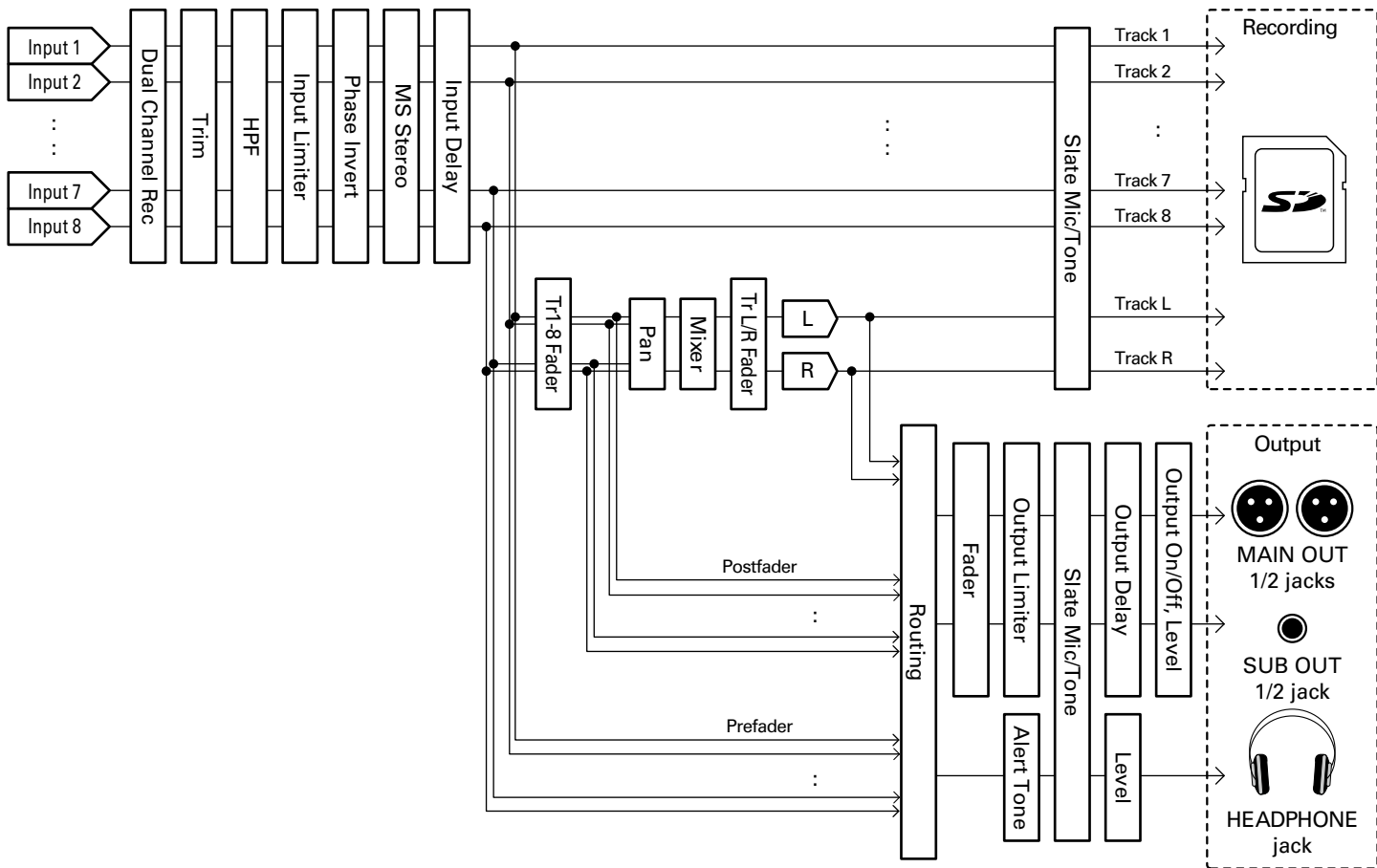

Adjusting the input signal monitoring balance

You can adjust the volume and panning of each input signal when monitoring during recording.

1. Open the mixer on the Home

Screen. (→ P.11)

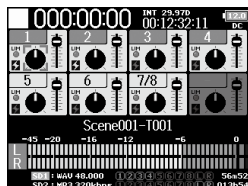

2. Adjust the parameter settings.



▪ Editing operations

Move cursor or change value: Turn 

Select parameter to change: Press 

Parameter	Setting range	Explanation
Fader	Mute, -48.0 - +24.0 dB	Adjusts the level of the input signal.
Panning	L100 - Center - R100	Adjusts the left-right stereo position of the sound.

HINT

- You can turn  to move the cursor, and also adjust the settings of the MAIN OUT 1/2 and SUB OUT 1/2 signals. (→ P.116)
- When a fader or pan knob is selected, press and hold  to reset it to its default value. If already set to its default value, selecting a fader mutes the track.

NOTE



- The MAIN OUT 1/2 and SUB OUT 1/2 faders do not affect the levels of the slate mic and slate tone.
- These volume and pan settings only affect the monitoring signals and the data being recorded on the L/R track.
- Settings are saved separately for each take that is already recorded and can be changed during playback. (→ P.52)
- Mix settings are not saved with the take when the recorded file format is MP3.

Setting the track knob function (Track Knob Option)



The Home Screen layout and track knob functions can be changed.

Setting the track knob function

1. Press .

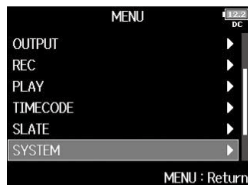
2. Use  to select SYSTEM,
and press .



3. Use  to select Track Knob
Option, and press .

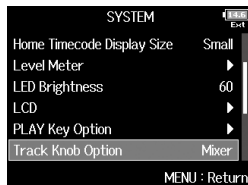



▶ Continue to one of the following procedures.

Adjusting faders with track knobs P. 76

Adjusting fader and pan settings with track knobs P. 77

Adjusting faders with track knobs

This restricts the track knob function to changing fader values. This mode makes it easy to check volume changes due to greater values and Auto Mix. (→ P. 99)

4. Use  to select Fader, and
press .



5. Open the mixer on the Home
Screen.

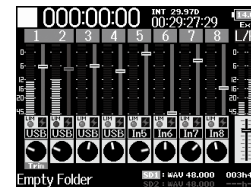

6. Use the  for a track to adjust its volume.

HINT



The TRIM and L/R figure values can be changed as follows.

Move cursor, change setting value: Turn 

Select parameter to change: Press 

Adjusting trim, fader and pan settings with track knobs



The track knobs can be used to quickly adjust the fader and pan settings of each track.

4. Use  to select Mixer, and press .

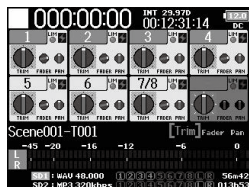

5. Open the mixer on the Home Screen.



6. Use  to select the parameter you want to adjust, and press .

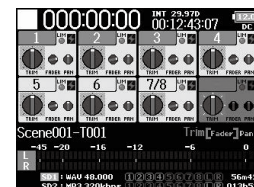





7. Use  of the track you want to adjust to change its setting value.

HINT

The position of the knob on the display always shows the current setting.

NOTE

After changing the parameter be adjusted, for example, if the positions of  and the knob on the display are different, the knob on the display will appear gray, and moving  will not affect that setting. In this case, if you adjust  to match the position of the knob on the display, the display knob and  will be relinked, and you will be able to use  to adjust its setting value again.

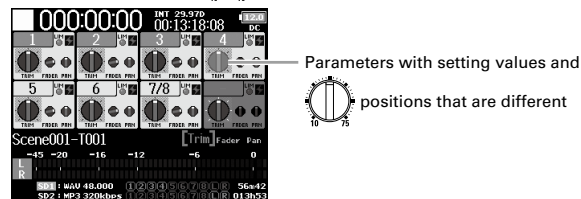

Adjusting the L/R track volume

1. Open the Home Screen.

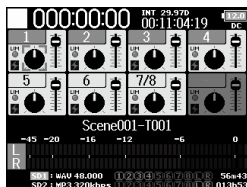

4. When finished adjusting, press **MENU** or **[] + [6]**.

NOTE

This is only enabled when Track Knob Option is not set to Fader. When set to Fader, you can adjust by using  to select.

2. Press **[] + [6]**.

NOTE

Shortcuts are disabled during playback.

3. Use  to adjust the volume.



NOTE

- Volume settings affect the results of recording.
- If only the L/R track is recorded, the L/R track fader setting for the take will be saved as 0dB.

Monitoring the input signals of specific tracks (PFL/SOLO)

You can monitor the input signals of specified tracks. Even tracks that have not been set to record can be input to the PFL screen and their input sounds monitored. This is convenient when using tracks as return inputs. You can also make various settings for these tracks.

1. Press **[PFL]** on the tracks that you want to monitor.

The selected track keys will light orange, and the PFL screen will open.

"PFL" or "SOLO" appears at the top of the display, and you will be able to monitor the input signal with headphones.

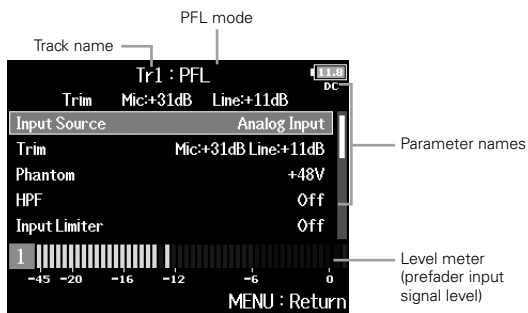

Parameter	Explanation
Input Source	This sets the input source.
Trim	This sets the input level.
Phantom	This sets phantom power.
HPF	This sets the high pass filter.
Input Limiter	This sets the limiter.
Fader	This sets the fader level.
Pan	This sets the panning.

Parameter	Explanation
Phase Invert	This sets the phase.
Side Mic Level	This sets the side mic level of a mid-side mic capsule.
Input Delay	This sets the input delay.
Plugin Power	This sets the plugin power.
Stereo Link	This sets the stereo link.
Stereo Link Mode	This sets the stereo link mode.
PFL Mode	This sets the monitoring volume on the PFL screen.

NOTE

This does not change the signals output from MAIN OUT and SUB OUT.

HINT

Use  to select parameters and change setting values.



2. Press **[PFL]** or **[MENU]** for the monitored tracks.

Open the Home Screen.



Setting the input source (Input Source)

Follow these procedures to set the input source of each track.

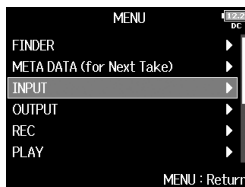

1. Press .

2. Use  to select INPUT, and press .

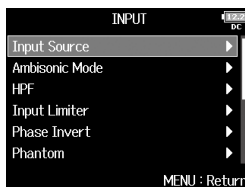

3. Use  to select Input Source, and press .



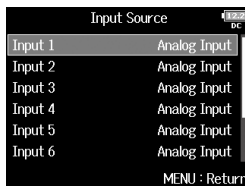

4. Use  to select a track, and press .



HINT

Select ALL to set all the tracks at the same time.

5. Use  to select the input source, and press .

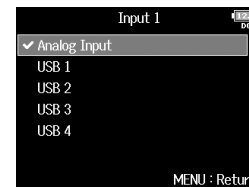

Setting value	Explanation
Analog Input	This treats signals input through INPUT 1–8 as input signals.
USB 1, USB 2, USB 3, USB 4	When Audio Interface with Rec (→ P.147) is set to On, computer output signals are treated as input signals.



NOTE

- When a mic capsule is connected, the Input Source cannot be changed for Inputs 1 and 2.
- When dual channel recording is enabled (→ P.33), the Input Source cannot be changed for the dual channel recording tracks.



Setting the monitoring volume on the PFL screen (PFL Mode)

On the PFL screen, you can set the monitored sound to be either prefader listening (PFL) or postfader solo (SOLO).

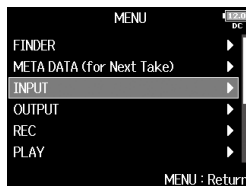

1. Press .

2. Use  to select INPUT,
and press .

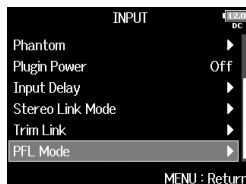

3. Use  to select PFL Mode,
and press .



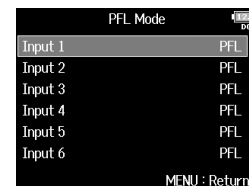

4. Use  to select the track,
and press .



HINT

Select ALL to set all the tracks at the same time.

5. Use  to select the mode,
and press .



Setting value	Explanation
PFL	Monitor the prefader sound.
SOLO	Monitor the postfader sound.



NOTE

When the PFL screen is open during playback, the monitoring sound will be post-fader (SOLO) regardless of the setting.



Cutting low-frequency noise (HPF)

The high pass filter can cut low frequencies to reduce the sound of wind, vocal pops and other noise.

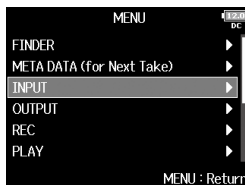

1. Press .

2. Use  to select INPUT,
and press .

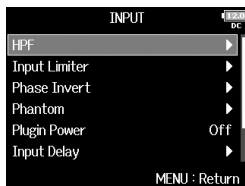

3. Use  to select HPF,
and press .



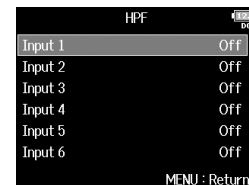

4. Use  to select the input,
and press .



HINT

Select ALL to set all inputs at the same time.

5. Use  to set the cutoff
frequency, and press .



NOTE

The HPF also affects dual channel recording data.

HINT

This can be set to Off or between 10 and 240 Hz.

Input limiter

The limiter can prevent distortion by controlling input signals that have excessively high levels.

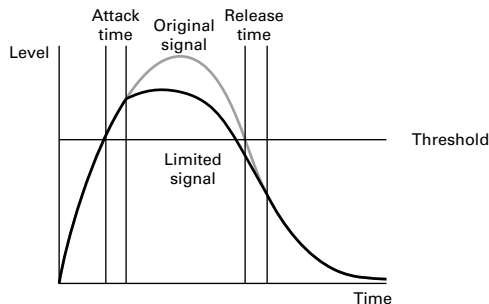



When the limiter is ON, if the input signal level exceeds the set threshold value, the signal level will be suppressed to prevent the sound from distorting.

The attack time is how long after the signal exceeds the threshold before the limiter starts operating. The release time is how long after the signal goes below the threshold before the limiter stops operating. You can change these two parameters to adjust the sound quality.

HINT

- The **F8** has a newly designed limiter that provides 10 dB of headroom, allowing signals to be kept well below the set threshold, therefore more effectively preventing distortion.

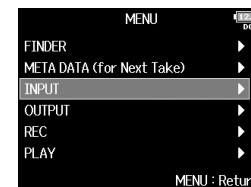

1. Press .

2. Use  to select INPUT, and press .

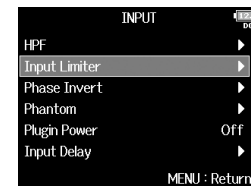

3. Use  to select Input Limiter, and press .



4. Use  to select the input, and press .

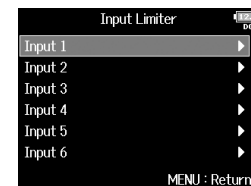

HINT

Select ALL to set all the inputs at the same time.

Input limiter (continued)

- ▶ Continue to one of the following procedures.

Using the limiter.....	P.84
Setting the type.....	P.85
Setting the threshold.....	P.86
Setting the attack time.....	P.86
Setting the release time.....	P.87
Setting the target level.....	P.88

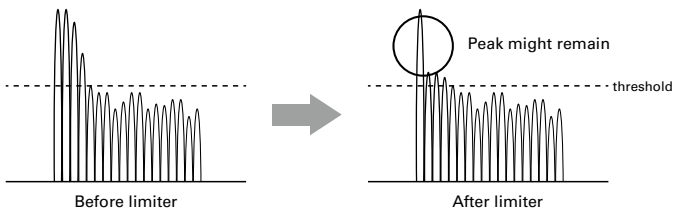

On (Normal)

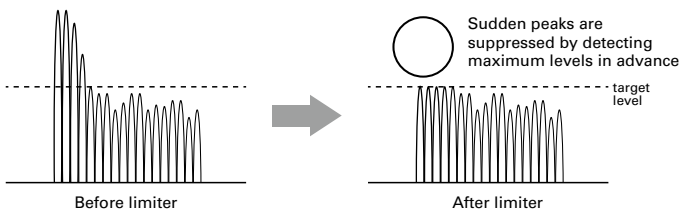

On (Advanced)



Using the limiter

5. Use  to select On/Off, and press .



6. Use  to select the setting, and press .

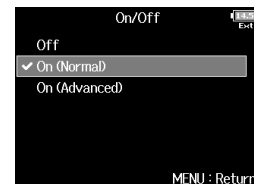

Setting value	Explanation
Off	This disables the limiter.
On (Normal)	This applies an ordinary limiter. The ratio is 20:1.
On (Advanced)	By detecting the maximum level in advance, this optimized limiter prevents distortion even more than ordinary limiter operation. The ratio is ∞ :1, providing increased internal headroom.



NOTE

When set to On (Advanced), the input latency of the **F8** increases 1 ms. When monitoring sounds being recorded with a mic in real-time, increased latency can cause interference between sound transmitted through the air from the source and the delayed monitored sound, possibly making accurate monitoring of the sounds difficult.



NOTE

- When set to On (Advanced), the following limiter parameter becomes available to set.
-Target Level
- When set to On (Advanced), the following limiter parameters cannot be set.
-Type
-Threshold
- Attack Time
- Release Time
- When set to On (Advanced), the Sample Rate cannot be set to 192 kHz. Moreover, when the Sample Rate is set to 192 kHz, the On (Advanced) setting cannot be selected.

Setting the type

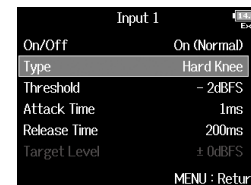
- 5.** Use  to select Type,
and press .



- 6.** Use  to select the type,
and press .

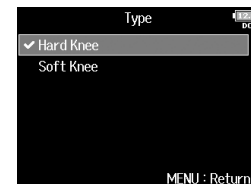

Setting value	Explanation
Hard Knee	Only peaks that exceed the threshold are attenuated. There is no effect below the threshold.
Soft Knee	The limiter gradually affects the signal about 6 dB below the threshold for a gentler effect.



NOTE

This setting can be made when On/Off is set to On (Normal).

Input limiter (continued)

Setting the threshold

This sets the level at which the limiter begins operating.

- 5.** Use  to select Threshold, and press .



- 6.** Use  to adjust the setting, and press .



HINT



This can be set from -16 to -2 dBFS.

NOTE

This setting can be made when On/Off is set to On (Normal).

Setting the attack time

This sets the amount of time until limiting starts after the input signal exceeds the threshold.

- 5.** Use  to select Attack Time, and press .



- 6.** Use  to adjust the time, and press .



HINT

This can be set from 1 to 4 ms.

NOTE

This setting can be made when On/Off is set to On (Normal).

Setting the release time

This sets the amount of time until limiting stops after the input signal goes below the threshold.

5. Use  to select Release

Time, and press .

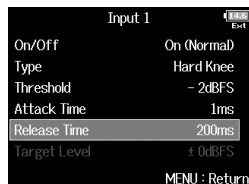

6. Use  to adjust the time,
and press .



MENU: Return

NOTE

This setting can be made when On/Off is set to On (Normal).



HINT

- Limiter operation is linked for tracks that have stereo link or MS stereo link enabled. If the signal for either linked channel reaches the threshold, the limiter will operate on both tracks.
- When the limiter is operating, the right-most segment of the level meter and the mixer limiter indicator on the display light yellow.

Input limiter (continued)

Setting the target level

When the limiter On/Off setting is set to On (Advanced), use this to set the target output level for the signal.

- 5.** Use  to select Target Level, and press .



- 6.** Use  to adjust the setting, and press .



HINT

- This can be set from -16 to 0 dBFS.
- After a signal passes through the limiter, it will not exceed the set target level value.

NOTE



This setting becomes available when On/Off is set to On (Advanced).

Inverting the input phase (Phase Invert)



The phase of the input signal can be inverted.

This is useful when sounds cancel each other out due to mic positioning.

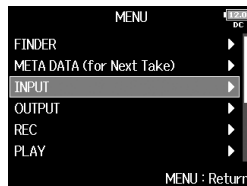

1. Press .

2. Use  to select INPUT,
and press .

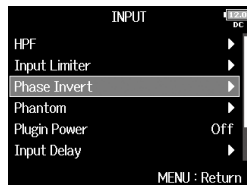

3. Use  to select Phase
Invert, and press .



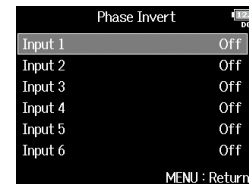

4. Use  to select the input,
and press .



HINT

Select ALL to set all inputs at the same time.

5. Use  to select On,
and press .

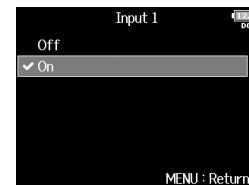

Changing the phantom power settings (Phantom)

The **F8** can provide phantom power. The voltage can be set to +24V or +48V and it can be turned on/off for each input separately.



HINT

Phantom power is a function that supplies power to devices that require an external power supply, including some condenser mics. The standard power is +48V, but some devices can operate with lower voltages.



NOTE

Do not use this function with a device that is not compatible with phantom power. Doing so could damage the device.

1. Press .

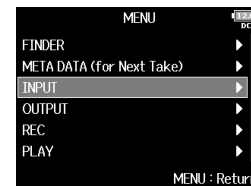
2. Use  to select INPUT, and press .



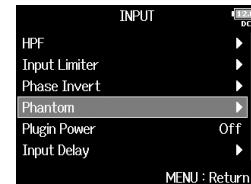

3. Use  to select Phantom, and press .





► Continue to one of the following procedures.

Using phantom power	P.91
Setting the voltage	P.91
Disabling phantom power during playback	P.92

Using phantom power

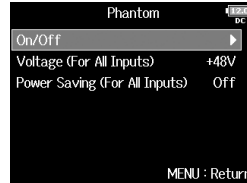
4. Use  to select On/Off, and press .



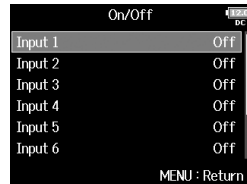

5. Use  to select the input, and press .



HINT

Select ALL to set all inputs at the same time.

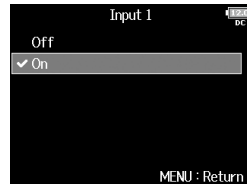

6. Use  to select On, and press .





NOTE

When a mic capsule is connected, phantom power is set to Off for inputs 1/2.

Setting the voltage

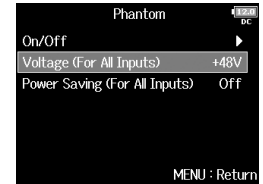
4. Use  to select Voltage (For All Inputs), and press .



5. Use  to select the voltage, and press .

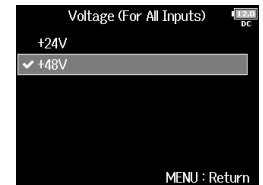



HINT



When using mics and other equipment that can operate with voltages less than +48V, selecting +24V can reduce power consumption by the **F8**.

Changing the phantom power settings (Phantom) (continued)

Disabling phantom power during playback

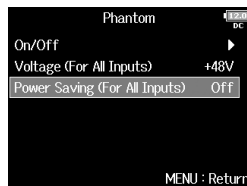
- 4.** Use  to select Power Saving (For All Inputs), and press .



- 5.** Use  to select On (Phantom off during play back), and press .

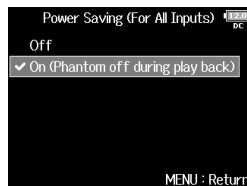

Setting value	Explanation
Off	Phantom power is supplied even during playback.
On (Phantom off during play back)	Phantom power is not supplied during playback. This can reduce the FB power consumption.

HINT

If mics do not need phantom power during playback, disabling it can reduce **FB** power consumption.



NOTE

This setting affects all inputs.



Changing the plugin power setting (Plugin Power)

Make this setting when a mic that is compatible with plug-in power is connected to the mic capsule's MIC/LINE input jack.

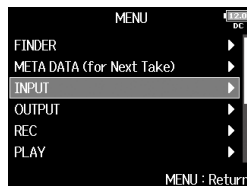

1. Press .

2. Use  to select INPUT,
and press .

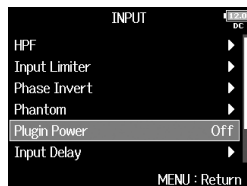

3. Use  to select Plugin
Power, and press .



4. Use  to select On,
and press .

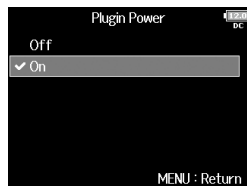



NOTE

This setting can be changed only when a mic capsule that supports plug-in power is connected.



Delaying input signals (Input Delay)

If there are differences in the timing of input signals, use this function to correct them when recording.

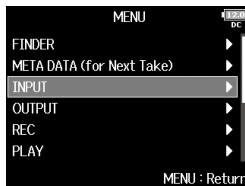

1. Press .

2. Use  to select INPUT,
and press .

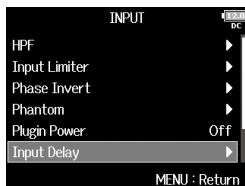

3. Use  to select Input
Delay, and press .



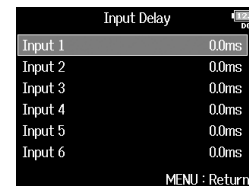

4. Use  to select the input,
and press .



HINT

Select ALL to set all inputs at the same time.

5. Use  to adjust the delay
time, and press .



HINT

This can be set from 0 to 30.0 ms.

NOTE

When Sample Rate is set to 192kHz, Input Delay is disabled.

Converting mid-side input to ordinary stereo (Stereo Link Mode)

Signals from a mid-side stereo mic input connected to stereo-linked inputs can be converted to an ordinary stereo signal. See "Linking inputs as a stereo pair" (→ P.27) for how to use stereo linking.

Mid-side stereo format overview

This technique creates a stereo recording from signals input by a directional mid mic that captures sound in the center and a bidirectional side mic that captures sounds from the left and right.



Mid-side recording allows you to change the stereo width by the adjusting the level of the side mic.

Since this technique can capture a wide stereo image, it is ideal for recording open spaces with numerous sound sources, such as orchestras, live concerts and soundscapes.

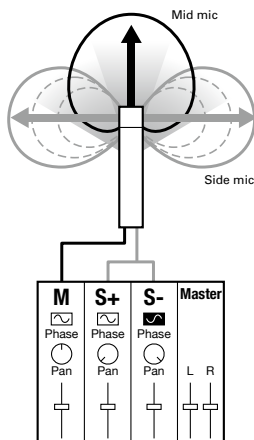

Mid-side recording is also extremely effective when you want to be able to control the amount of room ambience in a signal. For this reason, it is often used for live as well as studio recording. In addition, the stereo signal created by this technique is fully mono-compatible, making it especially useful when recording sound for film, video, or broadcast.



1. Press .

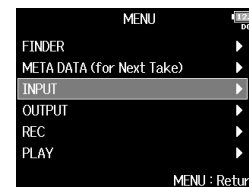

2. Use  to select INPUT,
and press .

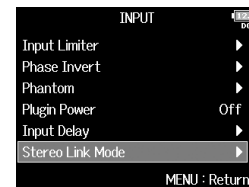

3. Use  to select Stereo
Link Mode, and press .





Converting mid-side input to ordinary stereo (Stereo Link Mode) (continued)

- 4.** Use  to select the input pair, and press .



HINT

Select ALL to set all input pairs at the same time.

- 5.** Use  to select MS Stereo Link, and press .



NOTE

- When MS Stereo Link is selected, odd-numbered inputs are handled as mid signals and even-numbered inputs as side signals.
- The MS Stereo Link setting is disabled if a ZOOM mic capsule is connected that cannot have L/R signals routed individually to inputs 1/2.

HINT



- Use  for each input to adjust the mid/side balance.
- The PFL screen allows you to adjust the side mic level for inputs 1/2 when a mid-side mic capsule is connected.

Setting value	Explanation
Stereo Link	When stereo-linked, inputs are handled normally.
MS Stereo Link	When stereo-linked, signals from a mid-side mic are converted to ordinary stereo.



Adjusting the input levels of multiple tracks simultaneously (Trim Link)

The input levels of multiple tracks can be linked and adjusted at the same time.

1. Press .

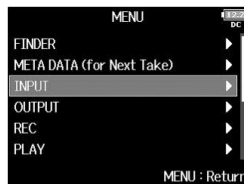
2. Use  to select INPUT,
and press .



3. Use  to select Trim Link,
and press .

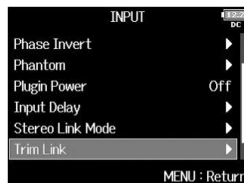

HINT

You can also open the Trim Link screen from the Home Screen by pressing **[3]** while pressing and holding .

4. Use  to select a track to link, and press .

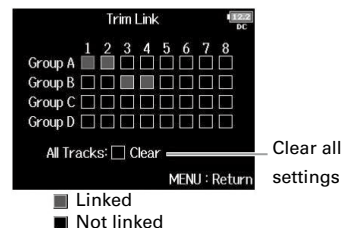

HINT

- You can use  for the first track in a link group to adjust all the input levels within that group at the same time.
- Icons for group names are shown next to linked tracks.

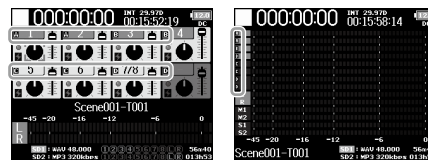



NOTE

- A track cannot be in more than one group at a time.
- The input levels of tracks set to MS Stereo Link will also be linked if those tracks are put into groups.
- The input levels of tracks that have a mic capsule connected will not be linked even if those tracks are put into groups.

Adjusting the side level of a mid-side mic capsule (Side Mic Level)

You can adjust the side mic level (stereo width) before recording when a mid-side mic capsule is connected.

1. Press **[PFL]** for track 1 or 2.

2. Use  to select Side Mic Level, and press .



3. Use  to adjust the side mic level, and press **[MENU]**.



HINT

This can be set to Off, RAW or in a range from -24 to +6 dB.

NOTE

- The more the side mic level is increased, the greater the stereo width.
- When set to RAW, recording will occur without stereo encoding. The stereo width of audio in RAW format can be adjusted after recording by using ZOOM MS Decoder or other plug-in software.
- This can be adjusted only when a mid-side type mic capsule is disconnected.

HINT



When dual channel recording is on, the side mic level can also be set for tracks 5/6, which correspond to tracks 1/2.

Changing the automatic mixing setting (Auto Mix)



When using multiple mics to capture audio during a meeting, for example, automatically attenuating the inputs of mics that are not in active use provides the following benefits.

- The likelihood of feedback is reduced.
- Background noise, including fans and crowds is suppressed to a certain level regardless of the number of people using mics.
- Sound quality degradation due to phase differences caused by variations in the distances of multiple mics is reduced.

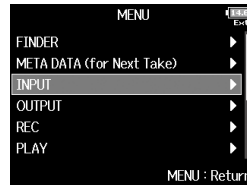

1. Press .

2. Use  to select INPUT, and press .



3. Use  to select Auto Mix, and press .



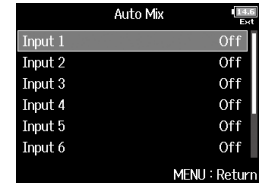

4. Use  to select a track, and press .



HINT

Select ALL to set all the tracks at the same time.

5. Use  to select On, and press .

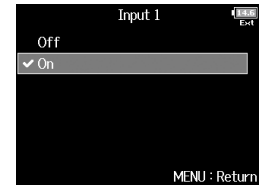

NOTE

- The following functions and settings cannot be used with this function.
 - The sampling rate cannot be set to 192 kHz.
 - The Ambisonic Mode format cannot be set to any value other than Off.
- When the sampling rate is set to 44.1–48.048 kHz and Auto Mix is set to On, the **F8** latency will increase 2 ms.
- When monitoring sounds being recorded with a mic in real-time, increased latency can cause interference between sound transmitted through the air from the source and the delayed monitored sound, possibly making accurate monitoring of the sounds difficult.

Changing the automatic mixing setting (Auto Mix)

When Track Knob Option is set to Fader and Auto Mix is enabled, the Home Screen will appear as follows.

Meters that show the amount of attenuation due to Auto Mix

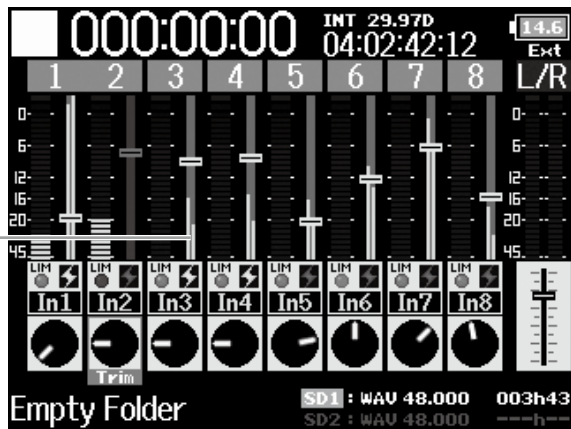



<Track Knob Option: Fader>



Setting the format of Ambisonic Mode

By connecting mics that can output ambisonics A-format signals to Inputs 1–4, audio can be converted to ambisonics B-format and recorded.

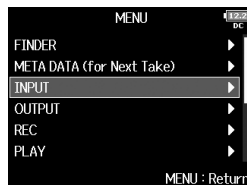

1. Press .

2. Use  to select INPUT, and press .



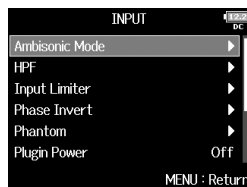

3. Use  to select Ambisonic Mode, and press .

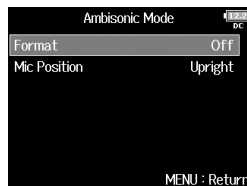

4. Use  to select Format, and press .



5. Use  to select the format, and press .

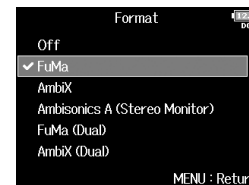

Changing the automatic mixing setting (Auto Mix) (continued)

FuMa

This converts the signals from Inputs 1-4 to the ambisonics FuMa B-format, and saves them as a 4-channel polyphonic file.

AmbiX

This converts the signals from Inputs 1-4 to the ambisonics AmbiX B-format, and saves them as a 4-channel polyphonic file.

Format: FuMa, AmbiX

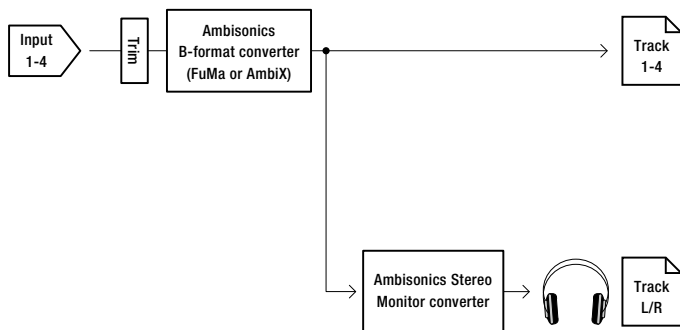

Ambisonics A (Stereo Monitor)

This saves the signals from Inputs 1-4 as a 4-channel polyphonic file without converting them to an ambisonics B-format. The monitoring signal is converted to ambisonics B-format and then to an ordinary stereo signal.

Format: Ambisonics A (Stereo Monitor)

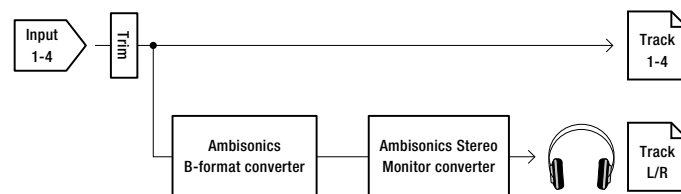

FuMa(Dual)

This converts the signals from Inputs 1-4 to the ambisonics FuMa B-format, and saves them as a 4-channel polyphonic file.

AmbiX(Dual)

This converts the signals from Inputs 1-4 to the ambisonics AmbiX B-format, and saves them as a 4-channel polyphonic file.

FuMa + AmbiX

This converts the signals from Inputs 1-4 to the ambisonics FuMa B-format, and records them to tracks 1-4. It also converts the signals from Inputs 1-4 to the ambisonics AmbiX B-format, and records them to tracks 5-8. These can be recorded at different input levels.

Format: FuMa (Dual), AmbiX (Dual), FuMa + AmbiX

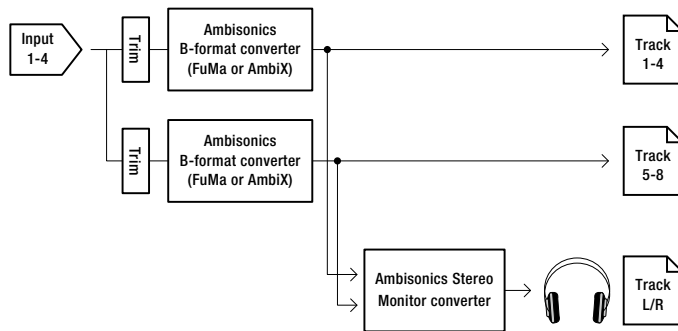

FuMa + Ambisonics A

This converts the signals from Inputs 1-4 to the ambisonics FuMa B-format, and records them to tracks 1-4. It also records the signals from Inputs 1-4 to tracks 5-8 without converting them to an ambisonics B-format. These can be recorded at different input levels.

AmbiX + Ambisonics A

This converts the signals from Inputs 1-4 to the ambisonics AmbiX B-format, and records them to tracks 1-4. It also records the signals from Inputs 1-4 to tracks 5-8 without converting them to an ambisonics B-format. These can be recorded at different input levels.

Format: FuMa + Ambisonics A, AmbiX + Ambisonics A

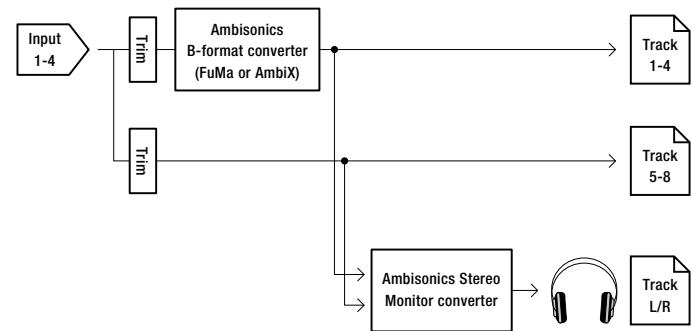



Changing the automatic mixing setting (Auto Mix) (continued)

NOTE

- The sampling rate can only be set to 192 kHz when the format of Ambisonic Mode is Off.
- Ambisonic files are saved as 4-channel polyphonic files, not as mono or stereo files.
- A ZOOM mic capsule can only be used when the format of Ambisonic Mode is Off.
- The following parameters cannot be set for tracks using Ambisonic Mode input.
 - Pan
 - Phase Invert
 - Side Mic Level
 - Input Delay
 - Stereo Link
 - Stereo Link Mode
 - Dual Channel Rec
 - Trim Link
- Files recorded when the format of Ambisonic Mode is not Off will play back as ambisonic audio sources rather than ordinary 4-channel polyphonic files. For this reason, these tracks cannot be panned or muted during playback.
- When the sampling rate is set to 44.1–48.048 kHz and Ambisonic Mode is not set to Off, the **FB** latency will increase 2 ms. When monitoring sounds being recorded with a mic in real-time, increased latency can cause interference between sound transmitted through the air from the source and the delayed monitored sound, possibly making accurate monitoring of the sounds difficult.
- This cannot be used with the Auto Mix function.

HINT

- Ambisonic Mode can be set during use as an audio interface (Multi Track).
- Even when the format of Ambisonic Mode is Off, you can press track  to monitor their input sounds. When PFL mode is set to PFL, you can monitor sounds before they are converted to ambisonics B-format. When PFL mode is set to SOLO, you can monitor sounds after they are converted to ambisonics B-format.
- The input levels of the Ambisonic Mode input tracks are linked, so  for Input 1 (or Input 5) can be used to adjust their input levels.
- The input enabled/disabled statuses of the Ambisonic Mode input tracks are linked, so the settings of all assigned tracks can be switched simultaneously by pressing any of their track keys.
- The following parameters that can be set on the PFL screen are linked for input tracks using Ambisonic Mode.
 - HPF
 - Input Limiter
 - Phantom
 - Fader
 - PFL Mode
 - Input Source
 - Input Level

When Ambisonic Mode is enabled, the Home Screen will appear as follows.

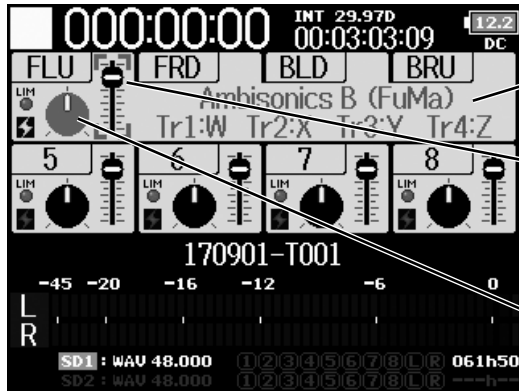

<Track Knob Option: Trim>

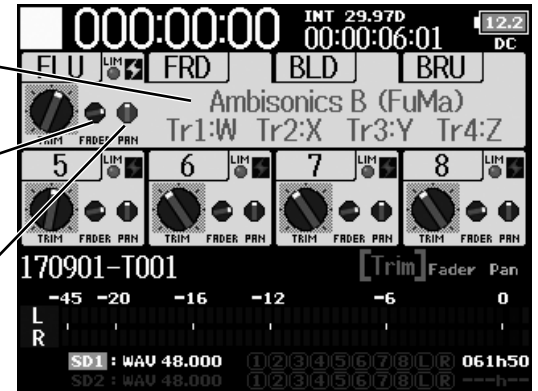

<Track Knob Option: Mixer>

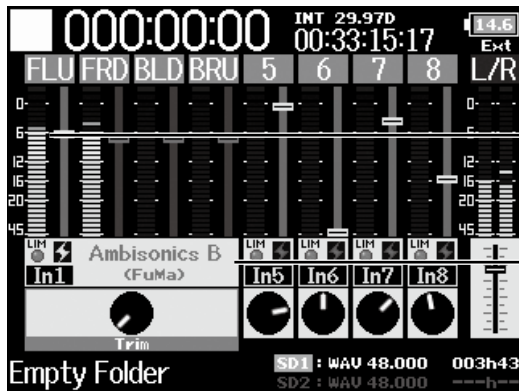

<Track Knob Option: Fader>

Format name

Track 1-4 fader

Pan disable



Track 1-4 fader

Format name



Setting the mic position used for ambisonic recording (Mic Position)

By setting the mic orientation used during ambisonic recording as an **FB** parameter, proper positioning can be maintained when converting to ambisonic B format if the mic orientation is changed from upright to upside down or horizontal.

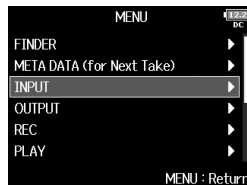

1. Press .

2. Use  to select INPUT, and press .



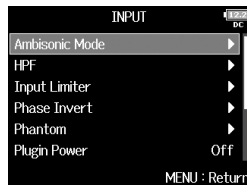

3. Use  to select Ambisonic Mode, and press .

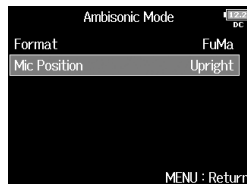

4. Use  to select Mic Position, and press .



5. Use  to select the mic orientation, and press .

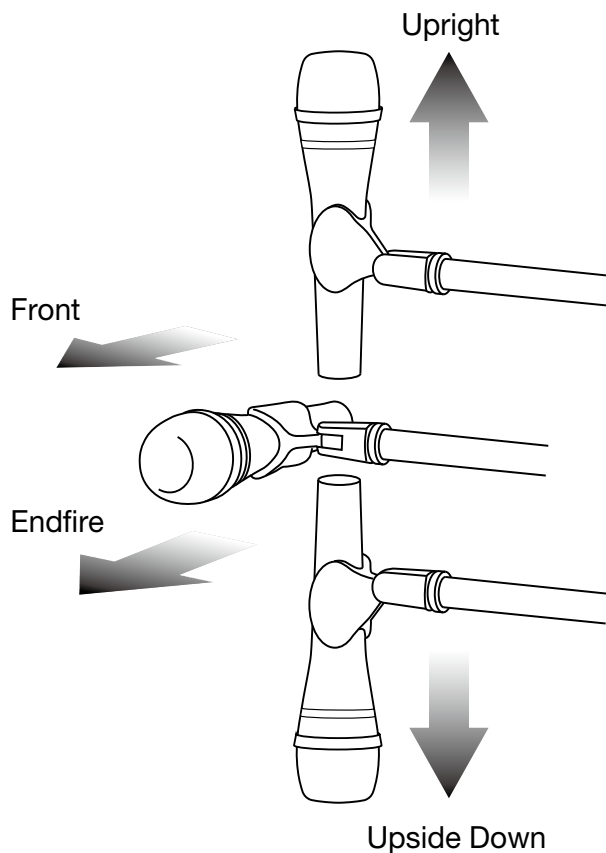

Setting value	Explanation
Upright	Use this setting to record with the mic upright.
Upside Down	Use this setting to record with the mic upside down.
Endfire	Use this setting to record with the mic oriented horizontally.

**HINT**

- Using the mic upright is recommended for ambisonic recording in order to minimize reflections from the floor and the mic itself.
- When it is difficult to use the mic in an upright orientation, you can place it upside down or pointing forward and change the Mic Position setting accordingly.



NOTE

- If this setting and the mic position do not match, sound positioning will not be properly re-created during conversion to ambisonic B format.



Setting signals sent to headphones (Headphone Routing)

You can set the type of signal sent to the headphone output to either prefader or postfader for each track.
You can also save 10 setting combinations (Setting 1 – Setting 10).

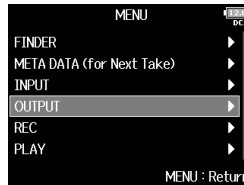

1. Press .

2. Use  to select OUTPUT,
and press .



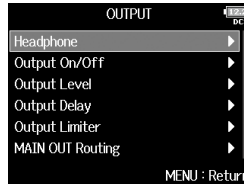

3. Use  to select Headphone,
and press .

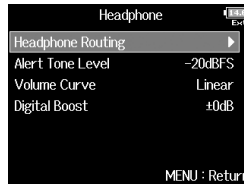

4. Use  to select Headphone
Routing, and press .



5. Use  and  to
select the setting you want
to change.



NOTE

- You can also press  + **7** to open the Headphone Routing screen.
- You can edit and save up to 10 signal settings.
- Settings are saved automatically.

► Continue to one of the following procedures.

Setting the routing P.109

Using mono headphone output P.110

Monitoring mid-side stereo signals P.110

Setting the routing

- 6.** Use  to select the tracks/outputs for headphone routing and press .

Mid-side stereo monitoring

Set tracks 1–8 to prefader (deactivates MS)

Cycles options:

- Change tracks 1–8 to postfader (cancels others)
- Change L/R to postfader (cancels others)
- Change M1/M2 to postfader (cancels others)
- Change S1/S2 to postfader (cancels others) (deactivates MS)
- Change U1–U4 to postfader (cancel others)

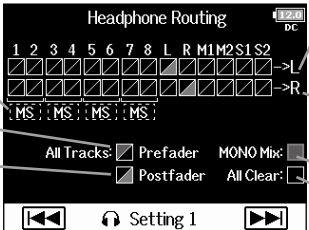

Tracks routed to the left headphone channel

Tracks routed to the right headphone channel

Mono mix

Clear all settings

Prefader selected
 Postfader selected
 Off

HINT

Press  to cycle through the options:
 Prefader → Postfader → Off.



NOTE

- You cannot set L/R , MAIN OUT 1/2 or SUB OUT 1/2 to prefader.
- When Audio Interface with Rec is set to On, USB tracks 1–4 can be assigned.
- You cannot select the 1–8, L/R , MAIN OUT 1/2, SUB OUT 1/2 and USB1–4 tracks at the same time. Selecting one will deselect any other.

- 7.** Press .

Setting signals sent to headphones (Headphone Routing) (continued)

Using mono headphone output



6. Use  to select MONO Mix, and press .



7. Press .

Monitoring mid-side stereo signals

Signals from a mid-side stereo mic can be converted to an ordinary stereo signal for monitoring.

6. Use  to select MS, and press .



7. Press .



NOTE

- This is disabled for stereo-linked tracks that have Stereo Link Mode set to MS Stereo Link.
- This is only enabled for tracks that have a mid-side microphone or mid-side mic capsule connected and the Side Mic Level set to RAW.
- When mid-side stereo monitoring is enabled, the prefader tracks will be routed automatically to the headphone channels, with the odd-numbered to the left and the even-numbered to the right. In this case, the routing cannot be changed manually.



Outputting alerts through headphones (Alert Tone Level)

The volume can be adjusted for alerts output to headphones when, for example, recording starts and stops.

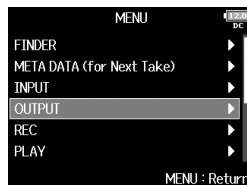

1. Press .

2. Use  to select OUTPUT,
and press .



3. Use  to select Headphone,
and press .



4. Use  to select Alert Tone
Level, and press .

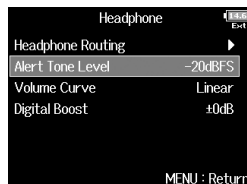

5. Use  to adjust the
volume, and press .



HINT



- This can be set to Off or between -48 and -12 dBFS.
- When set to Off, no alerts will be output.

When alerts sound	Sound type
Remaining battery low	880Hz tone 4 times every 30 seconds
Recording starts	1000Hz tone 1 time
Recording stops	880Hz tone 2 times
Recording not possible	880Hz tone 3 times



Setting the headphone output (Volume Curve)

The volume curve used when adjusting the headphone volume knob can be set.

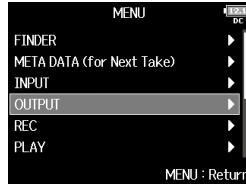

1. Press .

2. Use  to select OUTPUT, and press .



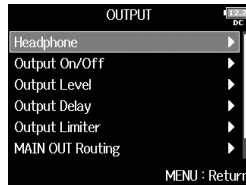

3. Use  to select Headphone, and press .

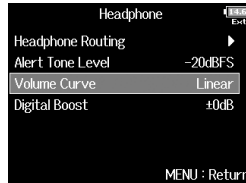

4. Use  to select Volume Curve, and press .



5. Use  to select the volume curve, and press .

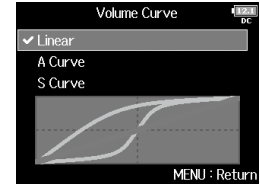



Setting value	Explanation
Linear	The volume will change evenly from the minimum value to the maximum value.
A Curve	The closer the volume is to its minimum position, the more rapidly it will change.
S Curve	The closer the volume is to its center position, the more rapidly it will change.



Boosting headphone output to alleviate interference from recorded sound (Digital Boost)

Boosting the headphone output alleviates the interference of sound waves traveling through the air with the headphone monitoring signal, enabling more accurate monitoring of the sound being recorded.

1. Press .

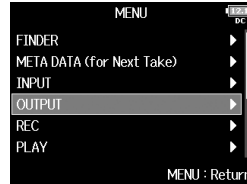
2. Use  to select OUTPUT, and press .



3. Use  to select Headphone, and press .

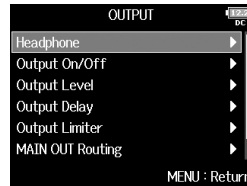

4. Use  to select Digital Boost, and press .

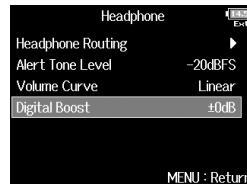

5. Use  to adjust the amount of boost, and press

.



HINT

The amount of boost can be set from 0 to +24 dB.

NOTE



In situations where the sound being recorded can be heard at the headphone monitoring position, sound waves traveling through the air can interfere with the sound heard from the headphones, altering the monitored sound. The more the sound heard through the headphones is delayed and the lower its volume, the greater the impact of the sound waves.

Digital Boost adds a set boost volume to the adjusted headphone volume level, reducing the impact of the sound waves that travel through the air.

Disabling outputs (Output On/Off)

By disabling outputs that you are not using, you can reduce power consumption and increase the length of operation time when using batteries.

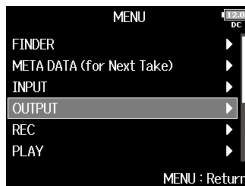

1. Press .

2. Use  to select OUTPUT,
and press .

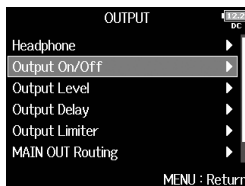

3. Use  to select Output
On/Off, and press .



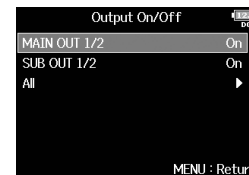

4. Use  to select the
output, and press .



HINT

Select ALL to set all outputs at the same time.

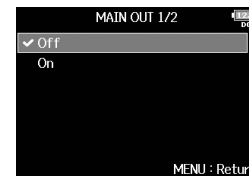

5. Use  to select Off,
and press .





Setting the standard output level (Output Level)

The standard output level can be changed.

1. Press .

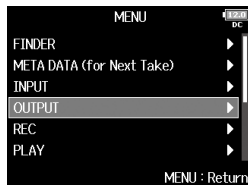
2. Use  to select OUTPUT, and press .



3. Use  to select Output Level, and press .

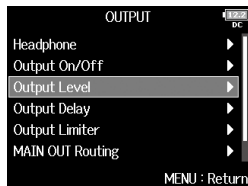

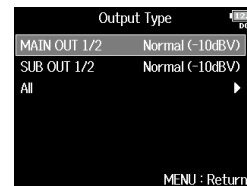

4. Use  to set the output type, and press .



HINT

Select ALL to set all outputs at the same time.

5. Use  to set the standard output level, and press .

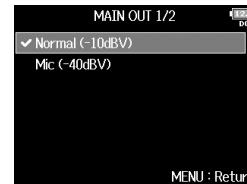



Setting value	Explanation
Normal (-10dBV)	This sets the standard level to -10 dBV.
Mic (-40dBV)	This sets the standard level to -40 dBV.

Setting output levels

The MAIN OUT 1/2 and SUB OUT 1/2 levels can be changed.

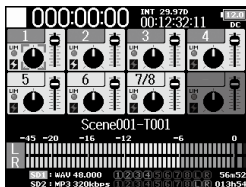
1. Open the mixer on the Home Screen. (→ P.11)



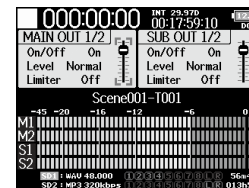

3. Use  to select a fader, and press .

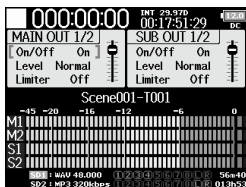

2. Use  to open the MAIN OUT 1/2 and SUB OUT 1/2 settings screen.



4. Use  to adjust the output level, and press .

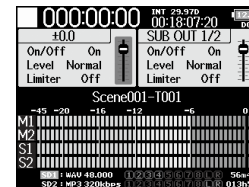



HINT

- This can be set to Mute or from -48.0 to $+12.0$ dB.
- You can also check and adjust various output settings on the MAIN OUT and SUB OUT setting screen.



Delaying output signals (Output Delay)

By delaying audio outputs, you can correct timing differences for signals input to other devices from the **F8**.

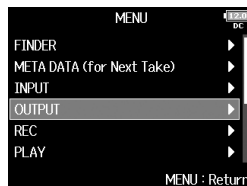

1. Press .

2. Use  to select OUTPUT,
and press .

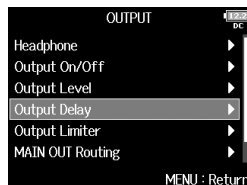

3. Use  to select Output
Delay, and press .



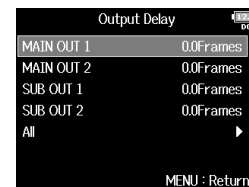

4. Use  to select the
output, and press .



HINT

Select ALL to set all outputs at the same time.

5. Use  to adjust the delay
in frames, and press .

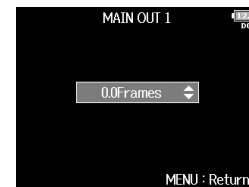

HINT

This can be set from 0.0 to 10.0 frames.

NOTE

- The delay in milliseconds depends on the frame rate of the selected timecode.
- When Sample Rate is set to 192kHz, Output Delay is disabled.



Output Limiter

Using a limiter on the output can protect devices connected to the output jacks.



HINT

For details about the effect of the limiter, see "Input limiter". (→ P.83)

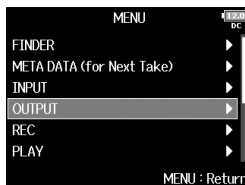

1. Press .

2. Use  to select OUTPUT,
and press .

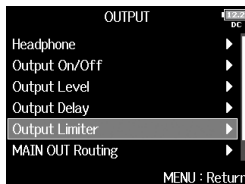

3. Use  to select Output
Limiter, and press .



4. Use  to select the
output, and press .

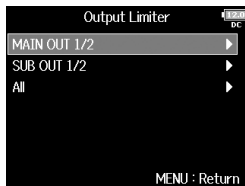



HINT

Select ALL to set all outputs at the same time.



► Continue to one of the following procedures.

Using the limiter	P.118
Setting the type	P.119
Setting the threshold.....	P.119
Setting the attack time.....	P.120
Setting the release time	P.120
Setting links	P.121

Using the limiter

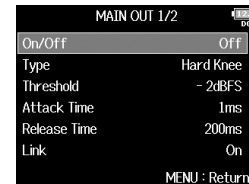

5. Use  to select On/Off,
and press .



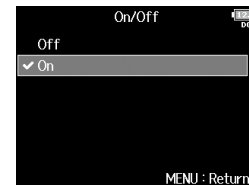

6. Use  to select On,
and press .

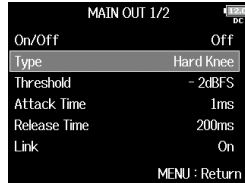

Setting the type

5. Use  to select Type, and press .



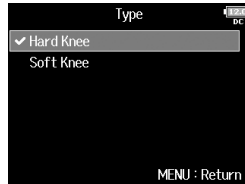

6. Use  to select the type, and press .



Setting value	Explanation
Hard Knee	Only peaks that exceed the threshold are attenuated. There is no effect below the threshold.
Soft Knee	The limiter gradually affects the output signal about 6 dB below the threshold for a gentler effect.

Setting the threshold

This sets the level at which the limiter begins operating.

5. Use  to select Threshold, and press .

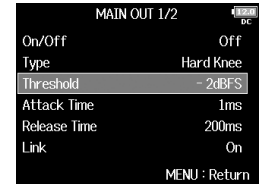

6. Use  to adjust the setting, and press .





HINT

This can be set from -16 to -2 dBFS.

Output Limiter (continued)

Setting the attack time

This sets the amount of time until limiting starts after the output signal exceeds the threshold.

- 5.** Use  to select Attack Time, and press .

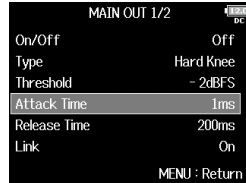

- 6.** Use  to adjust the time, and press .





HINT

This can be set from 1 to 4 ms.

Setting the release time

This sets the amount of time until limiting stops after the output signal goes below the threshold.

- 5.** Use  to select Release Time, and press .

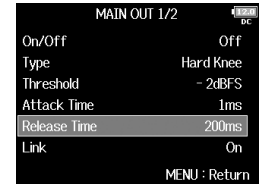

- 6.** Use  to adjust the time, and press .





HINT



This can be set from 1 to 500 ms.

Setting links

The limiter can be linked or applied separately to MAIN OUT 1 and MAIN OUT 2, as well as to SUB OUT 1 and SUB OUT 2.

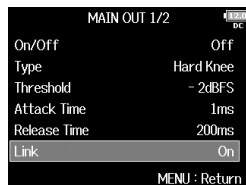
- 5.** Use  to select Link,
and press .



- 6.** Use  to select Off,
and press .

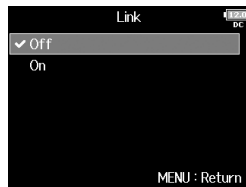



Setting value	Explanation
Off	Separates limiter operation.
On	Links limiter operation. If the signal for either linked signal reaches the threshold, the limiter will operate on both channels.



Selecting signals sent to the main outputs (MAIN OUT Routing)

You can send either prefader or postfader signals for each track to the main outputs.

1. Press .

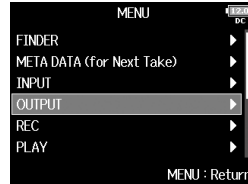
2. Use  to select OUTPUT, and press .



3. Use  to select MAIN OUT Routing, and press .

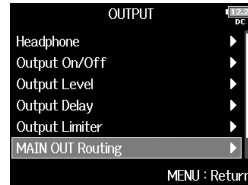

4. Use  to select the track for MAIN OUT 1 or MAIN OUT 2 routing and press .

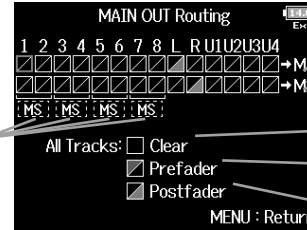

Converting input track stereo signals to mid-side stereo signals for output

- Select prefader
- Select postfader
- Off

Tracks routed to MAIN OUT 1

Tracks routed to MAIN OUT 2

Clear all settings

Set tracks 1–8 to prefader

Switches option:

- Change tracks 1–8 to postfader
- Change L/R tracks to postfader
- Change U1–U4 tracks to postfader

HINT

Press  to cycle through the options:
Prefader → Postfader → Off.

NOTE



- When Audio Interface with Rec is set to On, USB tracks 1–4 can be assigned.
- Tracks 1–8 can be set to Prefader or Postfader.
- The L/R tracks can only be set to Postfader.
- Tracks 1–8, L/R, and USB1–4 cannot be set at the same time. Selecting one type will deselect the other.
- When mid-side stereo monitoring is enabled, the pre-fader tracks will be routed automatically to the main outputs, with odd to the left and even to the right. In this case, the routing cannot be changed manually.

5. Press .

Selecting signals sent to the sub outputs (SUB OUT Routing)

You send either prefader or postfader signals for each track to the sub outputs.

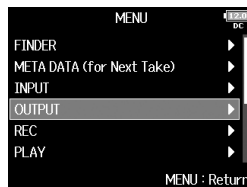

1. Press .

2. Use  to select OUTPUT, and press .

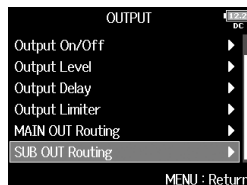

3. Use  to select SUB OUT Routing, and press .



4. Use  to select the track for SUB OUT 1 or SUB OUT 2 routing and press .

The screenshot shows the SUB OUT Routing screen with a grid of checkboxes for tracks 1-8, L, R, U1-U4, and S1-S2. Below the grid are options for 'All Tracks' (Clear, Prefader, Postfader) and 'Switch options' (Select prefader, Select postfader, Off). Annotations include: 'Tracks routed to SUB OUT 1' pointing to the S1 column, 'Tracks routed to SUB OUT 2' pointing to the S2 column, 'Clear all settings' pointing to the Clear checkbox, 'Set tracks 1-8 to prefader' pointing to the Prefader checkbox, 'Switch options: Change tracks 1-8 to postfader, Change L/R tracks to postfader, Change U1-U4 tracks to postfader' pointing to the Switch options section, and 'Converting input track stereo signals to mid-side stereo signals for output' pointing to the MS checkboxes.

HINT

Press  to cycle through the options: Prefader → Postfader → Off.

NOTE

- When Audio Interface with Rec is set to On, USB tracks 1-4 can be assigned.
- Tracks 1-8 can be set to Prefader or Postfader.
- The L/R tracks can only be set to Postfader.
- Tracks 1-8, L/R, and USB1-4 cannot be set at the same time. Selecting one type will deselect the other.
- When mid-side stereo monitoring is enabled, the pre-fader tracks will be routed automatically to the sub outputs, with odd to the left and even to the right. In this case, the routing cannot be changed manually.

5. Press .

Timecode overview

The **FB** can input and output SMPTE timecode.

Timecode is time information written to data when recording video and audio. It is used for video editing, control of other devices, and synchronization of audio and video.

Using timecode for editing

If video and audio data both have recorded timecode, aligning them to a timeline and synchronizing them together is easy when using nonlinear editing software.

HINT

The **FB** uses a precision oscillator that generates timecode with a high degree of accuracy (± 0.2 ppm, or approximately 0.5 frames per 24 hours).

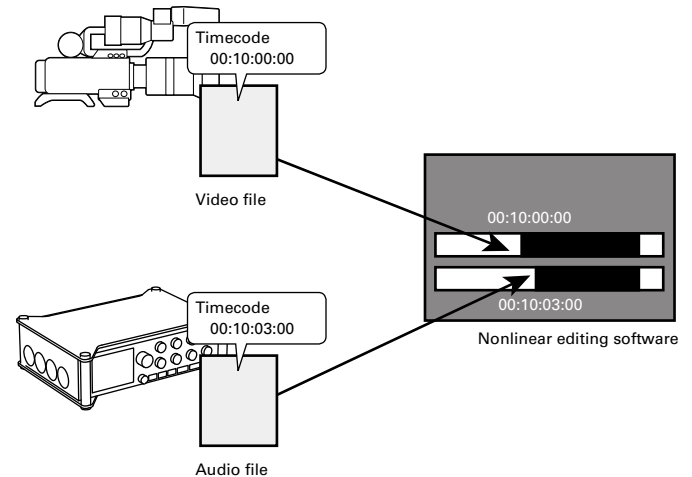

Connection examples

Connections like the following are possible, depending upon the specific equipment being used with the **F8**.

Synchronizing with a video camera

The **F8** records with mic input and transmits timecode. The **F8** saves the timecode that it generates with the audio data. The timecode received by the video camera is recorded with the video data.

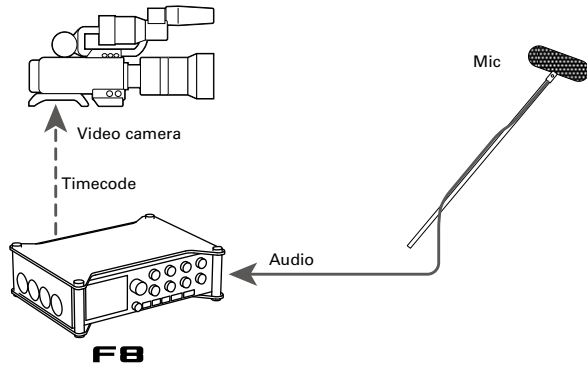

Inputting timecode

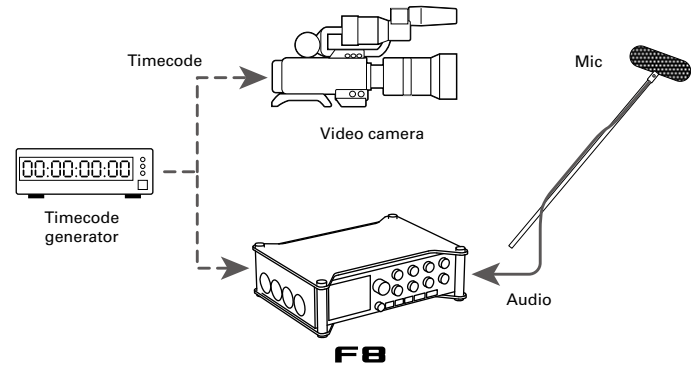

Timecode is transmitted from an external timecode generator. Both the **F8** and the video camera receive timecode and record it with their audio and video data.

The input timecode can also be used to synchronize the **F8** audio clock.





Setting timecode functions

1. Press .

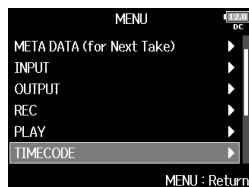
2. Use  to select TIMECODE,
and press .



3. Use  to select Timecode,
and press .

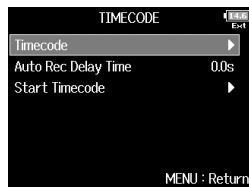

► Continue to one of the following procedures.

Setting the mode P.127

Stopping timecode output when recording is stopped . P.128

Synchronizing audio clock with external timecode P.129

Automatically enabling internal timecode when no external timecode is input P.129

Setting the user bits for internal timecode..... P.130

Setting the frame rate for internal timecode..... P.131



Jamming internal timecode P.132

Restarting internal timecode with a specified value P.132



Setting the mode

The timecode mode settings allow you to specify:

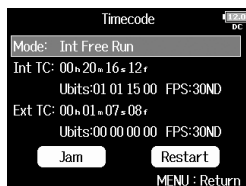

- Whether the **F8** generates timecode or receives external timecode
- Whether or not timecode continues running when not recording

4. Use  to select Mode, and press .

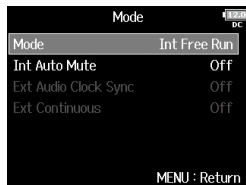

5. Use  to select Mode, and press .



6. Use  to select the mode, and press .





Setting value	Explanation
Off	No timecode will be written to the recording file. Timecode will not be output from the TIMECODE OUT jack.
Int Free Run	Internal timecode will be generated regardless of the recording mode. The internal timecode can be set manually using the following menu items: <ul style="list-style-type: none"> • MENU > TIMECODE > Timecode > Jam • MENU > TIMECODE > Timecode > Restart Timecode will always be output from the TIMECODE OUT jack.
Int Record Run	Internal timecode will be generated only when recording. The internal timecode can be set manually using the following menu items: <ul style="list-style-type: none"> • MENU > TIMECODE > Timecode > Jam • MENU > TIMECODE > Timecode > Restart When switching from another mode, or when recording stops, the internal timecode will stop at the last value.
Int RTC Run	Internal timecode will be generated regardless of the recording mode. In the following situations, the internal timecode will be synchronized (jammed) with the RTC (internal clock): <ul style="list-style-type: none"> • At startup • When Date/Time (RTC) has changed (→ P.19) • When switching to this timecode mode Timecode will always be output from the TIMECODE OUT jack.
Ext	The internal timecode will chase the external timecode. You can also enable the automatic generation of internal timecode when there is no external timecode. (→ P. 129)

Setting timecode functions (continued)



Setting value	Explanation
Ext Auto Rec	The internal timecode will chase the external timecode. You can also enable the automatic generation of internal timecode when there is no external timecode. (→ P.129) Recording starts automatically when external timecode input is detected. Recording stops automatically when external timecode stops.

Stopping timecode output when recording is stopped



You can set whether or not timecode is output from the TIMECODE OUT jack when recording is stopped.

- 4.** Use  to select Mode,
and press .



- 5.** Use  to select Int Auto
Mute, and press .



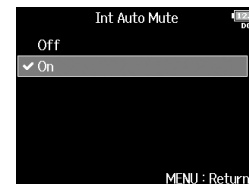

- 6.** Use  to select On,
and press .





NOTE

- Timecode will continue to be output when recording/playback is paused.
- This cannot be set when Mode is set to Off, Ext or Ext Auto Rec.

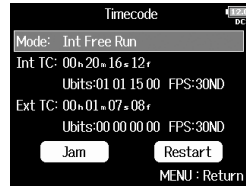

Synchronizing audio clock with external timecode

4. Use  to select Mode, and press .



5. Use  to select Ext Audio Clock Sync, and press .



6. Use  to select On, and press .





NOTE



- This cannot be set when Mode is set to Off, Int Free Run, Int Record Run or Int RTC Run.
- When there is no external timecode, the internal audio clock is enabled to preserve continuity.

Automatically enabling internal timecode when no external timecode is input

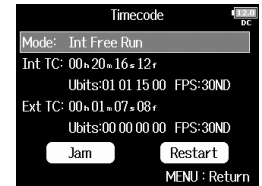

You can enable the automatic generation of internal timecode to preserve continuity when there is no external timecode.

4. Use  to select Mode, and press .

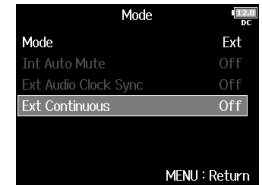

5. Use  to select Ext Continuous, and press .



6. Use  to select On, and press .

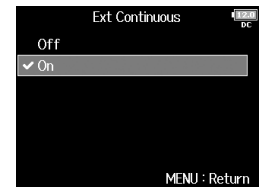

NOTE

- This cannot be set when Mode is set to Off, Int Free Run, Int Record Run or Int RTC Run.



Setting timecode functions (continued)

Setting the user bits for internal timecode



User bits are data that you can set to be included in the timecode. Up to 8 numbers (0–9) and letters (A–F) can be included. Recording date information, for example, can be useful when editing later.

Setting the user bits (Ubits) mode

4. Use  to select Ubits, and press .

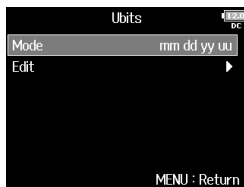
5. Use  to select Mode, and press .



6. Use  to select the mode, and press .





Setting value	Explanation
uu uu uu uu	You can set these values as you like on the Edit screen.
mm dd yy uu	The month, day and year are entered automatically in that order using the RTC setting. You can set the "uu" value as you like on the Edit screen.
dd mm yy uu	The, day, month and year are entered automatically in that order using the RTC setting. You can set the "uu" value as you like on the Edit screen.
yy mm dd uu	The year, month and day are entered automatically in that order using the RTC setting. You can set the "uu" value as you like on the Edit screen.

HINT

Only "uu" items can be changed.

Setting user bits (Ubits)

4. Use  to select Ubits, and press .

5. Use  to select Edit, and press .



6. Edit the value.

■ Editing operations

Move cursor or
change value: Turn 

Select parameter
to change: Press 



5. Use to select the frame rate, and press .

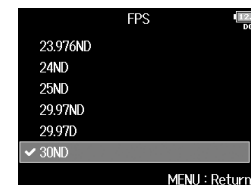

HINT

User bits can only consist of numbers from 0 to 9 and letters from A to F.

7. When done changing the

setting, use  to select

Enter, and press .



Setting the frame rate for internal timecode

4. Use to select FPS, and press .



Setting value	Explanation
23.976ND	This is the most common frame rate used with HD cameras and other high-definition video recording. The count is 0.1% slower than the actual time.
24ND	This is the standard frame rate used for recording film. This is also used with HD cameras.
25ND	This is the frame rate for PAL video. This is used for PAL video, which is used in Europe and other regions.
29.97ND	This is a frame rate used for NTSC color video and HD cameras. The count is 0.1% slower than the actual time. This is used for NTSC video, which is used in Japan, the United States and other countries.
29.97D	This is an adjusted frame rate that uses drop frames to make NTSC match the actual time. This is used with video for broadcast that requires the actual time frame to be matched.
30ND	This is used to synchronize sound with film that is being transferred to NTSC video. This is the standard frame rate used for black-and-white television in Japan, the United States and other countries.
30D	This rate is used for special applications. This synchronizes with film sound to be transferred to NTSC using 29.97fps drop frame. The count is 0.1% faster than the actual time.



NOTE

Matching frame rates must be set in advance on all connected video and audio devices.

Setting timecode functions (continued)



Jamming internal timecode

Timecode input through the TIMECODE IN jack is used to set internal timecode.

4. Use  to select Jam, and press .



Restarting internal timecode with a specified value

4. Use  to select Restart, and press .





5. Set the restart value.

- Editing operations

Move cursor or change value: Turn 

Select parameter to change: Press 





6. Use  to select Restart, and press .





Setting automatic timecode recording delay (Auto Rec Delay Time)

If set to record automatically when external timecode is received, unnecessary recording could occur when timecode is received for a brief amount time. In order to prevent this, you can set the amount of time until recording starts after timecode is received.

1. Press .

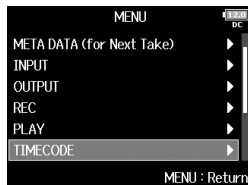
2. Use  to select TIMECODE, and press .



3. Use  to select Auto Rec Delay Time, and press .



4. Use  to adjust the time, and press .





HINT

This can be set from 0.0 to 8.0 s.



Setting timecode initialization used at startup (Start Timecode)

Since internal timecode stops when the **FB** is turned off, the timecode is automatically initialized (jammed) during startup. You can set the value that is used for jamming at that time.

1. Press .

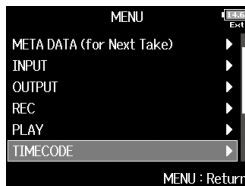
2. Use  to select TIMECODE, and press .



3. Use  to select Start Timecode, and press .

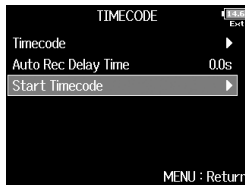



► Continue to one of the following procedures.



Setting how timecode is initialized at startup P.134

Correcting timecode errors after the power has been turned off P.135

Setting how timecode is initialized at startup

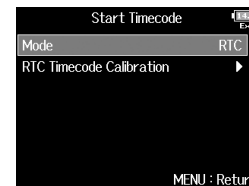
4. Use  to select Mode, and press .



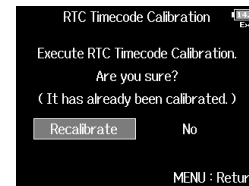

5. Use  to set how timecode is initialized, and press .





Setting value	Explanation
Restart Time	When the FB starts, the value set by Restart (→ P.132) is used to jam the internal timecode.
RTC	When the FB starts, its timecode is restored from the timecode when the power was turned off and advanced by the elapsed time using the Date/Time (RTC) setting (→ P.19). Since RTC is less precise than internal timecode, discrepancies will occur.

Correcting timecode errors after the power has been turned off

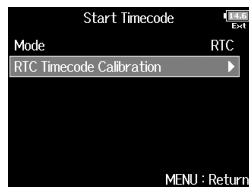

When the mode of Start Timecode is set to RTC, turning the power off lowers the timecode precision, this function can improve the error to the value close to 0.2 ppm when the power has been turned off.

- 4.** Use  to select RTC Timecode Calibration, and press .

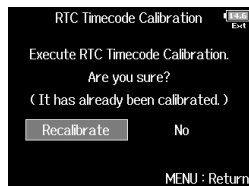

- 5.** Use  to select Recalibrate, and press .



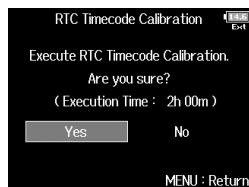

- 6.** Use  to select Yes, and press .



- 7.** Calibration completes.



- 6.** To cancel calibration, press , and use  to select Yes, and press .

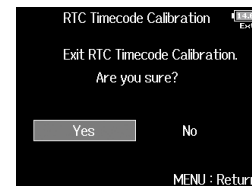

NOTE

- Calibration should be conducted once after updating the firmware.
- After calibrating once, the result will be retained.
- If the **F8** is moved to and used in an extremely hot or cold location, timecode precision could change slightly when the power is turned off. In such cases, we recommend calibrating it again.
- Calibration is not possible when Audio Interface with Rec is set to On.
- Calibration is only possible when StartTimecode mode is set to RTC.
- Calibration is not possible when an **FRC-8** is connected.

Slate mic and slate tone overview

When recording with the **F8**, you can add audio comments that describe, for example, the scene being filmed or the anticipated cuts. You can also record slate tone signals that can be used to synchronize with video.

The **F8** has a built-in slate mic for recording comments and the ability to output a variable frequency tone signal.

HINT

A "slate" is a clapperboard used when recording video.



NOTE

- The slate mic and slate tone cannot be used at the same time.
- The slate mic and slate tone cannot be used during audio file playback.



Recording with the slate mic (Slate Mic)

You can use the built-in slate mic to record comments and to keep notes about recorded takes.

1. Press .

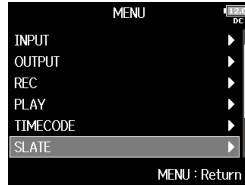
2. Use  to select SLATE,
and press .





3. Use  to select Slate Mic,
and press .



► Continue to one of the following procedures.

Setting the volume	P.137
Setting the routing	P.138
Recording	P.139
Disabling the slate mic.....	P.139

Setting the volume

4. Use  to select Level,
and press .

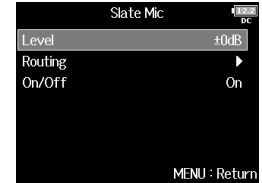

5. Use  to adjust the level,
and press .





HINT
This can be set from 0 to 24 dB.



Recording with the slate mic (Slate Mic) (continued)

Setting the routing

Set the destination for the slate mic signal.

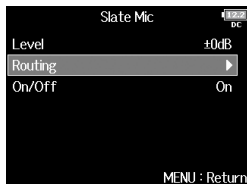
4. Use  to select Routing, and press .



5. Use  to select the tracks/outputs for slate mic signal routing and press .

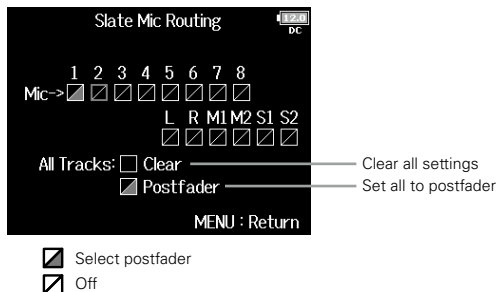

NOTE

Routing to tracks 1–8 is not possible when operating the **F8** as an audio interface (Stereo Mix).

HINT

Press  to switch between Postfader and Off.

6. Press .

Recording

4. Press  to start recording.

5. Push  left toward the mic symbol and release.

6. To disable the slate mic, push  left toward the mic symbol again and release.

NOTE



- When the slate mic is in use, other signals input to the tracks that it is routed to are muted.
- The slate mic signal is always routed to the headphone L/R channels regardless of other routing settings.
- The MAIN OUT 1/2 and SUB OUT 1/2 faders do not affect the levels of the slate mic and slate tone.

HINT



If you push and hold  left toward the mic symbol for two or more seconds, the slate mic will be enabled until you release the switch.

Disabling the slate mic

You can set the slate mic so that it will not be enabled if  is accidentally pushed left toward the mic symbol.

4. Use  to select On/Off, and press .



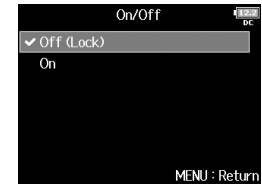

5. Use  to select Off (Lock), and press .





Recording a slate tone (Slate Tone)

By adding a slate tone when the recording starts, aligning audio to video during editing will be easier. You can also use a slate tone to coordinate levels with connected equipment.

1. Press .

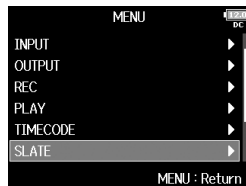
2. Use  to select SLATE,
and press .





3. Use  to select Slate
Tone, and press .



► Continue to one of the following procedures.

Setting the volume	P.140
Setting the frequency	P.141
Setting the routing	P.141
Recording	P.142
Disabling the slate tone	P.143

Setting the volume

4. Use  to select Level,
and press .





5. Use  to adjust the level,
and press .





HINT

This can be set from -20 to 0 dBFS.

Setting the frequency

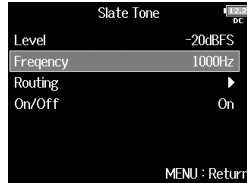
4. Use  to select Frequency, and press .



5. Use  to adjust the frequency, and press .

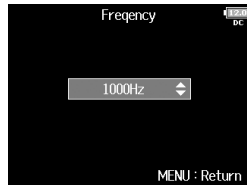



HINT

This can be set from 100 to 10,000 Hz.

Setting the routing

Set the destination for the slate tone signal.

4. Use  to select Routing, and press .

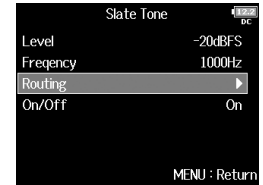

5. Use  to select the tracks/outputs for slate tone signal routing and press .

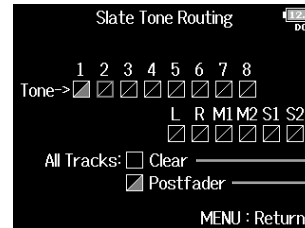

Clear — Clear all settings
 Postfader — Set all to postfader

- Select postfader
- Off

NOTE

Routing to tracks 1–8 is not possible when operating the **F8** as an audio interface (Stereo Mix).

Recording a slate tone (Slate Tone) (continued)

HINT

Press  to switch between Postfader and Off.

6. Press .

Recording

4. Press  to start recording.

5. Push  right toward the tone symbol and release.

NOTE



- When the slate tone is in use, other signals input to the tracks that it is routed to are muted.
- The slate tone signal is always routed to the headphone L/R channels regardless of other routing settings.
- The MAIN OUT 1/2 and SUB OUT 1/2 faders do not affect the levels of the slate mic and slate tone.

HINT



If you push and hold  right toward the tone symbol for one or more seconds, the slate tone will be enabled until you push the switch toward the tone symbol again.

Disabling the slate tone

You can set the slate tone so that it will not be enabled if  is accidentally pushed right toward the tone symbol.

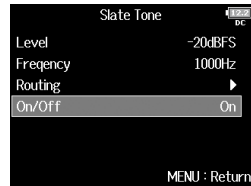
- 4.** Use  to select On/Off, and press .



- 5.** Use  to select Off (Lock), and press .

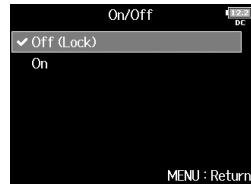



Exchanging data with a computer (SD Card Reader)



By connecting the **FB** to a computer, you can check and copy data on SD cards.

Connecting to a computer

1. Press .

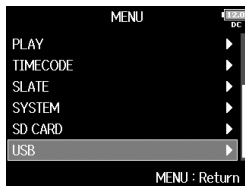
2. Use  to select USB,
and press .



3. Use  to select SD Card
Reader, and press .

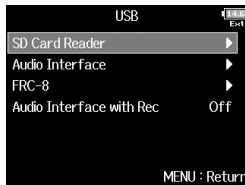

4. Connect the **FB** and computer with a USB cable.

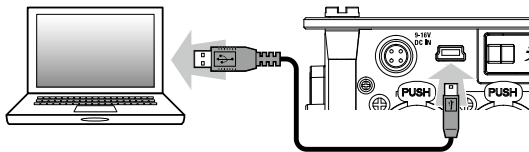

NOTE

- The following operating systems are supported:
Windows: Windows 7 or later
Mac OS: Mac OS X (10.8 or later)
- The **FB** cannot operate on USB bus power. Use the internal batteries, the dedicated AC adapter or an external DC power supply to power it.

HINT

When the **FB** is connected to a computer, the SD cards loaded in slots 1 and 2 are recognized as separate SD cards.

Disconnecting

1. Disconnect on the computer.

Windows: Select **FB** from the "Safely Remove Hardware and Eject Media" icon on the bottom of the computer screen.

Mac OS: Drag and drop the **FB** icon to the Trash.

NOTE

Always follow correct computer disconnection procedures before removing the USB cable.

2. Disconnect the cable from the computer and the



FB, and press .

Using as an audio interface (Audio Interface)



F8 input signals can be input directly to a computer or an iOS device, and playback signals coming from a computer or an iOS device can be output from the **F8**.

Connecting to a computer or an iOS device

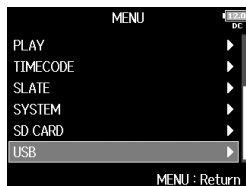

1. Press .

2. Use  to select USB, and press .

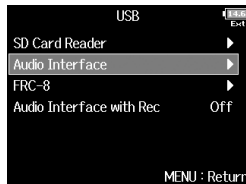

3. Use  to select Audio Interface, and press .



4. Use  to select the mode and connected device, and press .



Setting value	Explanation
Stereo Mix (PC/Mac)	This is a 2-in/2-out connection mode for Mac/Windows and sends tracks 1-8 as a stereo mix.
Stereo Mix (iPad)	This is a 2-in/2-out connection mode for iOS devices and sends tracks 1-8 as a stereo mix.
MultiTrack (PC/Mac)	This is an 8-in/4-out connection mode for Mac/Windows and sends tracks 1-8 as separate signals (cannot be used with an iOS device). A driver is necessary for use with Windows. Download the driver from the ZOOM website (www.zoom.co.jp/).

5. Use a USB cable to connect the **F8** and the computer or iOS device.

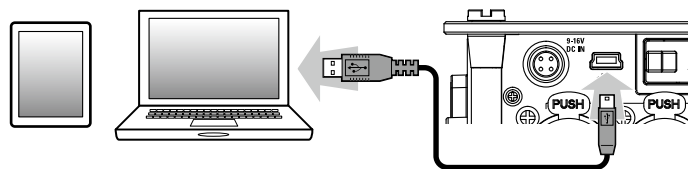



Using as an audio interface (Audio Interface) (continued)

NOTE



- A Lightning to USB Camera Adapter is necessary to connect an iOS device.
- The **FB** cannot operate on USB bus power. Use the internal batteries, the dedicated AC adapter or an external DC power supply to power it.
- When the **FB** is used as an audio interface and the sampling rate is set to 44.1/48 kHz, latency increases 2 ms. When latency increases while monitoring sounds being recorded with a mic in real-time, interference occurs between sound transmitted through the air from the source and the delayed monitored sound, possibly making accurate monitoring of the sounds difficult.

Disconnecting

1. Press .

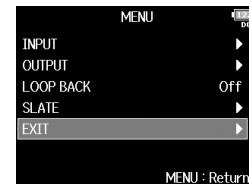
2. Use  to select Exit,
and press .



3. Use  to select Yes,
and press .

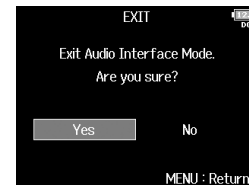



4. Disconnect the cable from the computer or iOS device
and the **FB**.

Using SD card recording and audio interface functions at the same time (Audio Interface with Rec)



In addition to the two SD cards, a computer can also be used for recording backup.

Connecting

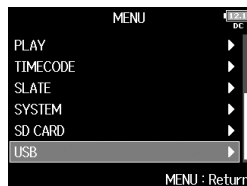

1. Press .

2. Use  to select USB, and press .

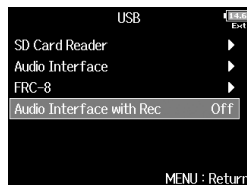

3. Use  to select Audio Interface with Rec, and press .



4. Use  to select On, and press .

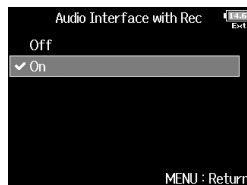

5. Use a USB cable to connect the **F8** and the computer.



Using SD card recording and audio interface functions at the same time (Audio Interface with Rec) (continued)

NOTE

- The **FB** cannot operate on USB bus power. Use the internal batteries, the dedicated AC adapter or an external DC power supply to power it.
- Audio Interface with Rec cannot be used with the following settings and functions.
 - Sampling rate settings other than 44.1/48 kHz
 - SD Card Reader (→ P.144)
 - Audio Interface (→ P.145)
 - **FRC-8** (→ P.152)
- A driver is necessary for use with Windows. Download the driver from the ZOOM website (www.zoom.co.jp/).
- When Audio Interface with Rec is set to On, the sampling rate cannot be changed.
- When Audio Interface with Rec is set to On, files with sampling rates that differ from the **FB** setting cannot be played.
- Set the input source to USB1-4 (→ P. 80) or set USB1-4 to the output routing (→ P109, 122, 123) to monitor sound played back from the computer. (→ P. 80)
- When Audio Interface with Rec is set to On, the **FB** latency will increase 2 ms. When monitoring sounds being recorded with a mic in real-time, increased latency can cause interference between sound transmitted through the air from the source and the delayed monitored sound, possibly making accurate monitoring of the sounds difficult.

Disconnecting

1. Press .

2. Use  to select Off, and press .

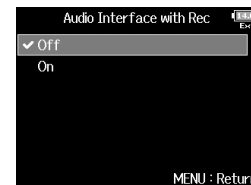

3. Disconnect the cable from the computer and the **FB**.

Audio interface block diagrams

Stereo Mix

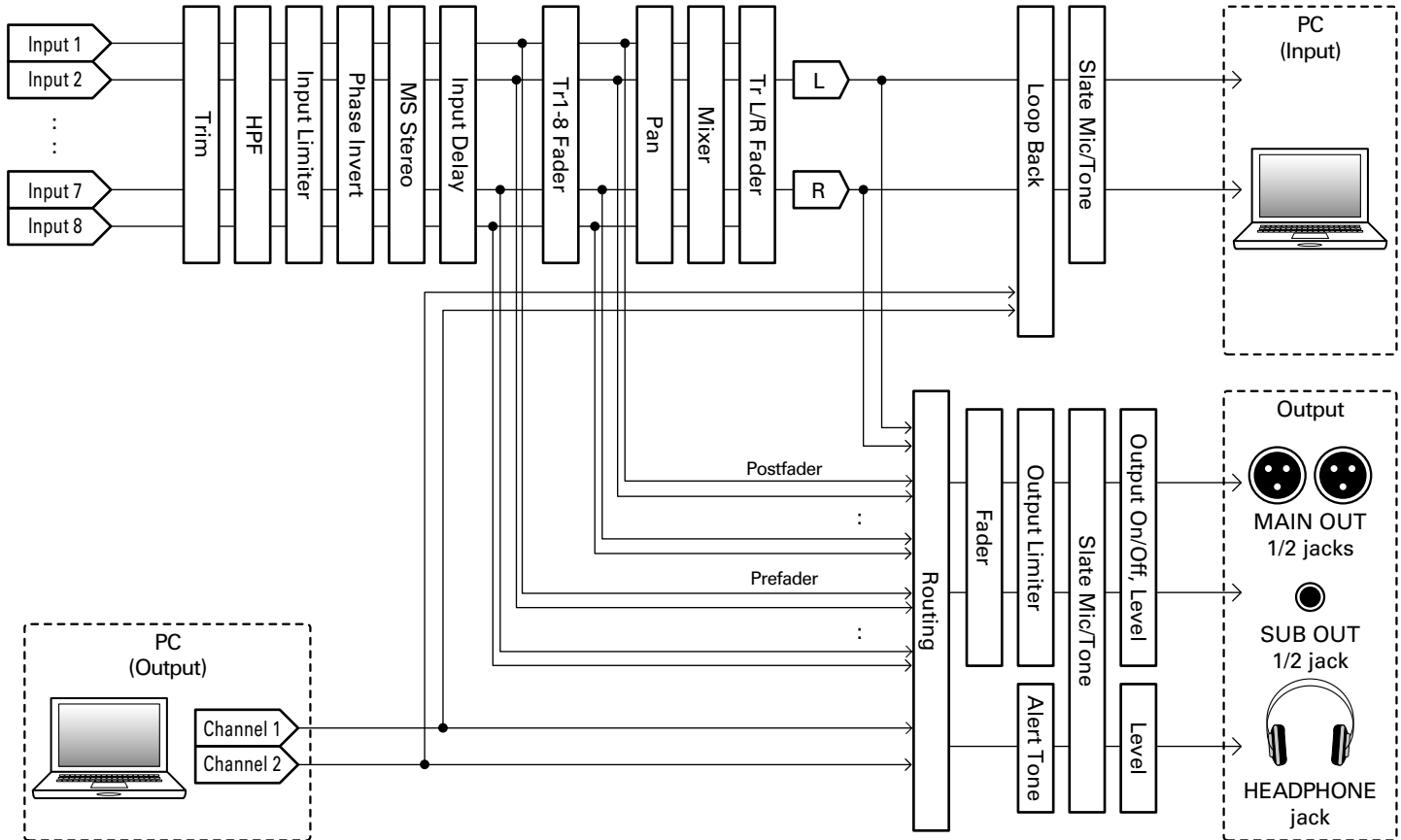

Audio interface block diagrams (continued)

Multi Track

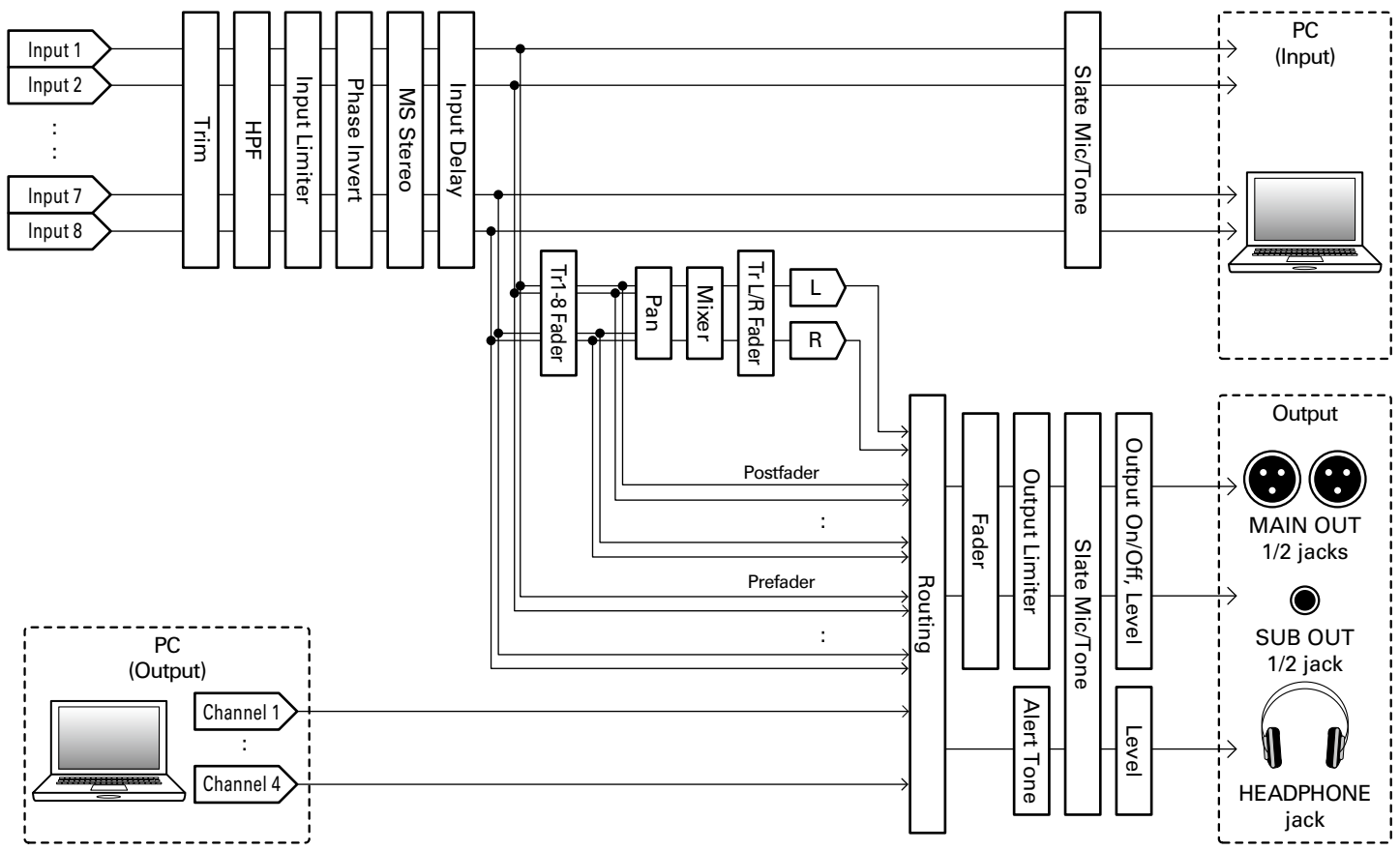

Audio interface settings



The following settings can be made when using the **F8** as an audio interface. See the relevant pages for details about operation.

Setting loop back (Stereo Mix only)



This function allows the playback sound from the computer or iOS device and the **F8** inputs to be mixed and sent back to the computer or iOS device (loop back).

You can use this function to add narration to music played back from the computer and record the mix or stream it from the computer, for example.

1. Press .

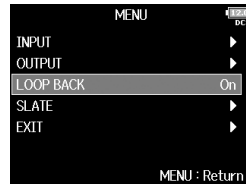
2. Use  to select LOOP BACK, and press .



3. Use  to select On, and press .

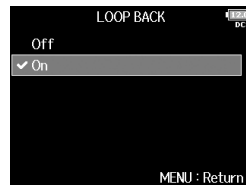

Mixing inputs

You can adjust the mix balance of input signals sent to the computer or iOS device. When using Multitrack mode, the individual inputs will be sent. When using Stereo Mix mode, the mixed stereo signal will be sent.

1. Open the mixer on the Home

Screen. (→ P.11)





2. Adjust the parameter settings.

See "Adjusting the input signal monitoring balance" (→ P.75) for how to change settings.



Using an FRC-8 as a controller (Connect)

By connecting an **FRC-8** to the **F8**, you can use it to adjust trim, fader and pan settings, for example.

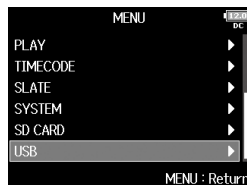

1. Press .

2. Use  to select USB,
and press .

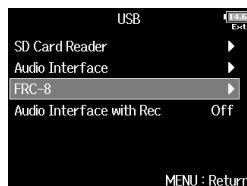

3. Use  to select FRC-8,
and press .



4. Use  to select Connect,
and press .

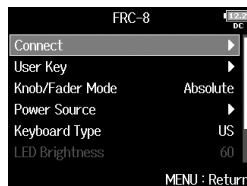

5. Use a USB cable to connect the **F8** and
the **FRC-8**.

6. Turn the **FRC-8** power ON.



NOTE

When disconnecting the **FRC-8**, select "Disconnect" before unplugging the USB cable.



Setting the type of keyboard connected to the FRC-8 (Keyboard Type)

You can connect a PC keyboard to the **FRC-8** and use it to input characters.
Set the type of PC keyboard connected to the **FRC-8**.

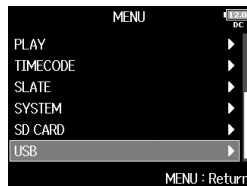

1. Press .

2. Use  to select USB,
and press .



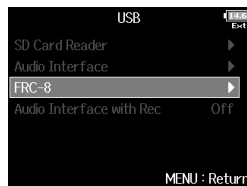

3. Use  to select FRC-8,
and press .

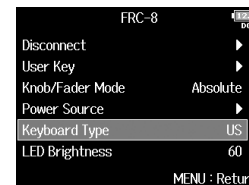

4. Use  to select Keyboard
Type and press .



5. Use  to select the type,
and press .

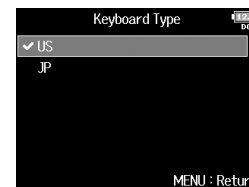



Setting value	Explanation
US	Use for English-language keyboards.
JP	Use for Japanese keyboards.



Setting FRC-8 fader and knob operation (Knob/Fader Mode)

How the **FRC-8** faders and TRIM/PAN knobs operate when their positions differ from actual parameter values can be set.

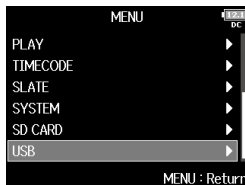

1. Press .

2. Use  to select USB, and press .



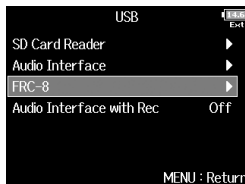

3. Use  to select FRC-8, and press .

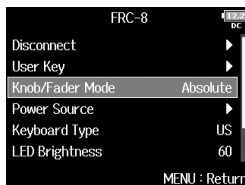

4. Use  to select Knob/Fader Mode, and press .



5. Use  to select the FRC-8 fader and knob operation, and press .

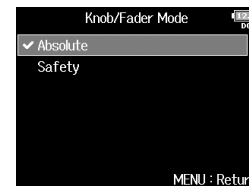

Setting value	Explanation
Absolute	When a knob or fader is operated, the parameter value will change to the value shown by that knob or fader.
Safety	When a knob or fader is operated, the parameter value will not change until the knob or fader first matches that value.



NOTE

The **FRC-8** headphone volume operation cannot be changed.



Setting user keys for the FRC-8 (User Key)

You can assign functions to the **FRC-8** user keys.

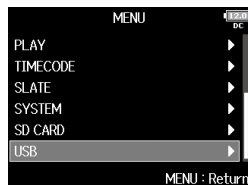

1. Press .

2. Use  to select USB,
and press .



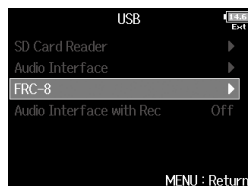

3. Use  to select FRC-8,
and press .



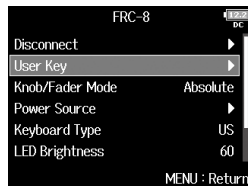

4. Use  to select User Key,
and press .

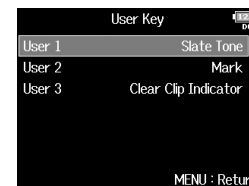

5. Use  to select the key to
which to assign a function,
and press .



6. Use  to select the
function to assign,
and press .

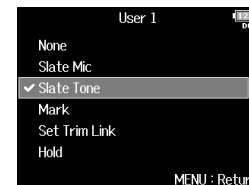



Setting value	Explanation
None	No function is assigned.
Slate Mic	Enable and disable the slate mic.
Slate Tone	Generate and stop slate tones.
Mark	Add marks to WAV format takes during recording and playback.
SetTrim Link	Open the MENU > INPUT > Trim Link screen.
Hold	Use to disable the keys set with "Key Hold Target".
Clear Clip Indicator	Clear the level meter clipping indicators.
Circled	Circle the currently selected take.



Setting the power supply used by the FRC-8 (Power Source)

Set the DC power supply shutdown voltage, nominal voltage and type of batteries so that the remaining power supply charge can be shown accurately. On this menu page, you can check the voltage of each power supply and the remaining battery capacity.

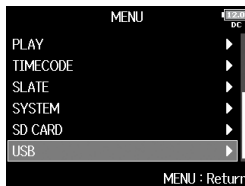

1. Press .

2. Use  to select USB,
and press .

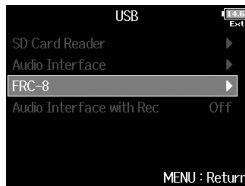

3. Use  to select FRC-8,
and press .



4. Use  to select Power
Source, and press .

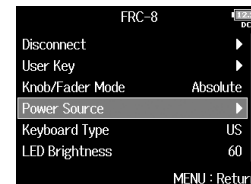

Power settings for the **FRC-8** are the same as for the **FB**. See "Setting the power supply used" (→ P.22).

NOTE

When multiple power supplies are connected, they will be used in the following order of priority.



1. DC power supply (Ext DC)
2. AA batteries (Int AA)

The voltages of each power supply are shown on the display.



Setting the FRC-8 LED brightness (LED Brightness)

You can adjust the brightness of the LEDs on the **FRC-8**.

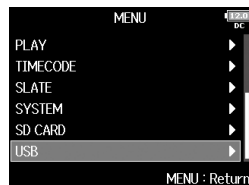

1. Press .

2. Use  to select USB,
and press .



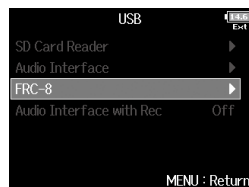

3. Use  to select FRC-8,
and press .



4. Use  to select LED
Brightness, and press .



5. Use  to adjust the
brightness, and press .



HINT

This can be set from 5 to 100.

Updating the FRC-8 firmware

You can check the **FRC-8** firmware version and update it to the latest version.
The latest update file can be downloaded from the ZOOM website (www.zoom.co.jp).

1. See "Using an **FRC-8** as a controller" (→P.152), and connect the **F8** and the **FRC-8**.

NOTE

Updating is not possible if the remaining battery or DC power supply charge is low. In this case, replace the batteries with new ones or use a charged DC power supply.



2. Copy the update file to the root directory on an SD card.

3. Load the SD card into the SD CARD 1 slot.



NOTE

If an SD card is loaded in the SD CARD 2 slot, eject it.

4. Press .

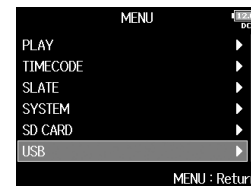
5. Use  to select USB, and press .





6. Use  to select FRC-8, and press .



- ▶ Continue to one of the following procedures.



Checking the firmware version	P.159
Updating the firmware	P.159

Checking the firmware version

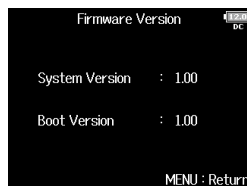

7. Use  to select Firmware Version, and press .



Updating the firmware

7. Use  to select Update Firmware, and press .



8. Use  to select Yes, and press .

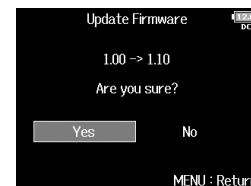

NOTE

Do not turn the power off, remove an SD card or disconnect the USB cable during an update. Doing so could cause the **FRC-8** to become unstartable.

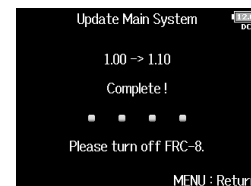

9. After the update completes, turn the **FRC-8** power off.





Setting how timecode is shown (Home Timecode Display Size)

You can change the size of the timecode display on the Home Screen.

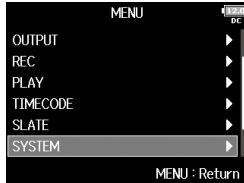

1. Press .

2. Use  to select SYSTEM, and press .



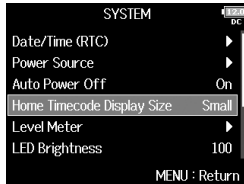

3. Use  to select Home Timecode Display Size, and press .



4. Use  to select the size, and press .





Setting value	Explanation
Small	The timecode is small and the time counter is large. 
Big	The timecode is large and the time counter is small. 



Setting level meter appearance (Level Meter)

You can set how the level meters appear on the display.

1. Press .

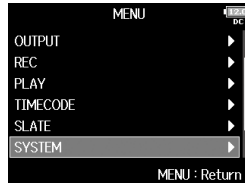
2. Use  to select SYSTEM, and press .



3. Use  to select Level Meter, and press .

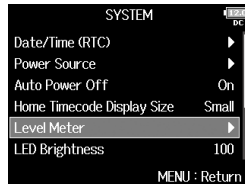



► Continue to one of the following procedures.



Setting the type	P.161
Setting the peak hold time	P.162
Setting the level meter resolution	P.163
Setting which track level meters are shown on the Home Screen	P.163
Showing track names on level meters	P.164
Setting the level meter reference.	P.164

Setting the type

You can set whether the level meters use VU or Peak style.

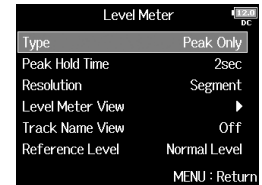

4. Use  to select Type, and press .



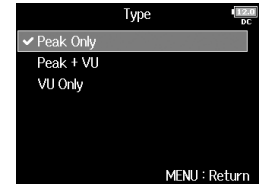

5. Use  to select the type, and press .





Setting level meter appearance (Level Meter) (continued)

Setting value	Explanation
Peak Only	 <p>The actual peak level of the signal (dBFS) is shown.</p>
Peak + VU	 <p>Both VU and peak level are shown simultaneously. In this mode, the bars function as a VU meter except for the right-most bar, which shows the peak level.</p>
VU Only	 <p>This display style is close to human hearing.</p>

Setting the peak hold time

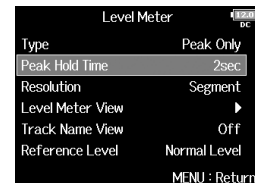

- 4.** Use  to select Peak Hold Time, and press .



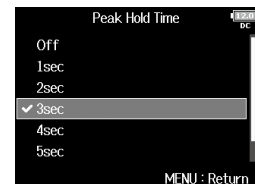

- 5.** Use  to adjust the peak hold time, and press .



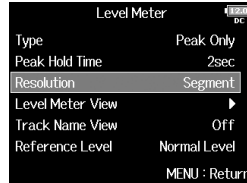

Setting the level meter resolution

4. Use  to select Resolution, and press .





5. Use  to select the resolution, and press .



Setting value	Explanation
Segment	 (Shown when set to VU Only)
Solid	 (Shown when set to VU Only)

Setting which track level meters are shown on the Home Screen

You can change which tracks are shown on the Home Screen.

4. Use  to select Level Meter View, then View1 - View4, and press .

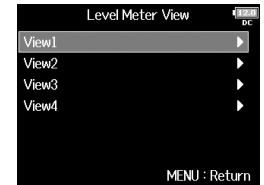

5. Use  to select tracks to show, and press .

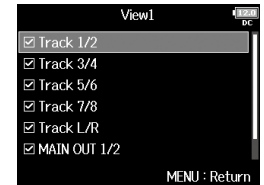

HINT
Multiple tracks can be shown. Not showing any tracks is also possible. If none of the check boxes are checked, no track level meters will appear on the Home Screen.

6. Press .

Setting level meter appearance (Level Meter) (continued)

Showing track names on level meters

4. Use  to select Track Name

View, and press .

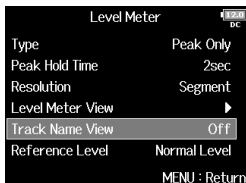

5. Use  to select On,

and press .

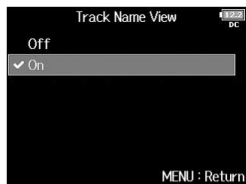

Setting the level meter reference

4. Use  to select Reference

Level, and press .

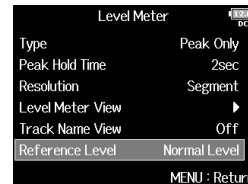



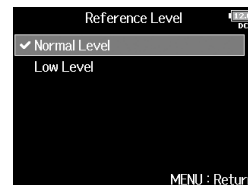

5. Use  to select the

reference level setting,

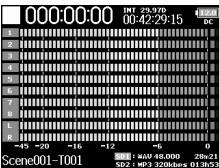
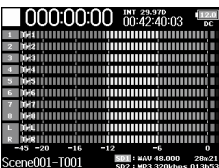
and press .





Setting value	Explanation
Off	The track names are not shown on the level meters. 
On	The track names set with the "Track Name" setting (→ P. 48) are shown on the level meters. 

Setting value	Explanation	
	When level meter type is Peak Only	When level meter type is Peak + VU or VU Only
Normal Level	 <p>The center of the level meter is -12 dBFS. Clear monitoring of levels higher than -12 dBFS is possible.</p>	 <p>The center of the level meter is 0 VU (-20 dBFS). Clear monitoring of levels higher than 0 VU (-20 dBFS) is possible.</p>
Low Level	 <p>The center of the level meter is -20 dBFS. Clear monitoring of levels lower than -20 dBFS is possible.</p>	 <p>The center of the level meter is -10 VU (-30 dBFS). Clear monitoring of levels lower than -10 VU (-30 dBFS) is possible.</p>



Setting the LED brightness (LED Brightness)

You can adjust the brightness of the LED level meters on the front of the **F8**.

1. Press .

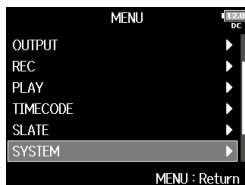
2. Use  to select SYSTEM,
and press .



3. Use  to select LED
Brightness, and press .

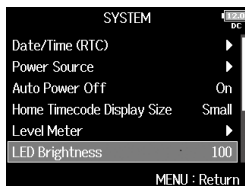

4. Use  to adjust the
brightness, and press .

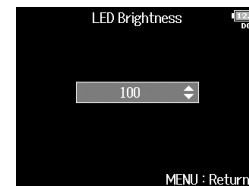



HINT

This can be set from 5 to 100.



Making display settings (LCD)

You can make settings related to the display.

1. Press .

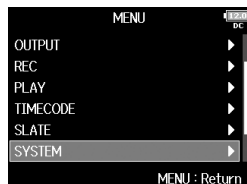
2. Use  to select SYSTEM,
and press .



3. Use  to select LCD,
and press .

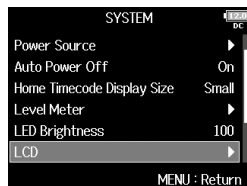



► Continue to one of the following procedures.

Setting the display brightness.....	P.167
Changing the display backlight setting.....	P.168
Making the display easier to read under bright light	P.168

Setting the display brightness

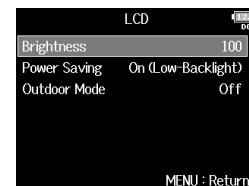
4. Use  to select
Brightness, and press .



5. Use  to adjust the
brightness, and press .





HINT

This can be set from 5 to 100.

Making display settings (LCD) (continued)

Changing the display backlight setting

You can set the display backlight to dim after 30 seconds without use.

- 4.** Use  to select Power Saving, and press .

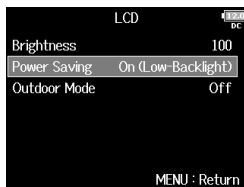

- 5.** Use  to select the setting, and press .

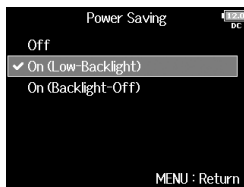



Making the display easier to read under bright light

The display can be set to be easier to read in bright environments including in sunlight.

- 4.** Use  to select Outdoor Mode, and press .



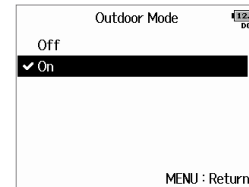

- 5.** Use  to select On, and press .





Setting value	Explanation
Off	The backlight brightness does not change even after time passes without use.
On (Low-Backlight)	The backlight dims after time without use.
On (Backlight-Off)	The backlight turns off after time without use.

You can set how marks are added when  is pressed while recording or playing back a WAV format file.

1. Press .

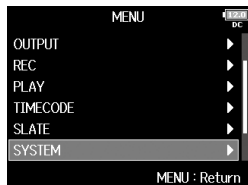
2. Use  to select SYSTEM, and press .



3. Use  to select PLAY Key Option, and press .

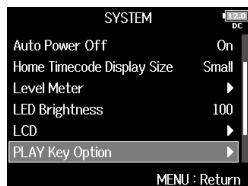



▶ Continue to one of the following procedures.



Setting how marks are added when recording.....P.169

Setting how marks are added when playingP.170

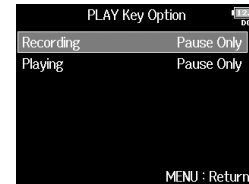

Setting how marks are added when recording

4. Use  to select Recording, and press .



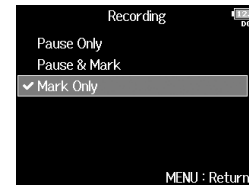

5. Use  to select how marks are added, and press .





Setting value	Explanation
Pause Only	Pressing  will pause without adding a mark.
Pause & Mark	Pressing  will pause and add a mark.
Mark Only	Pressing  will add a mark without pausing.

Adding marks when pausing (PLAY Key Option)

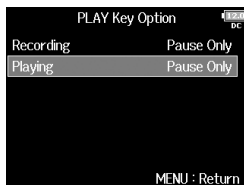

Setting how marks are added when playing

4. Use  to select **Playing**,
and press .





5. Use  to select how
marks are added, and
press .





Setting value	Explanation
Pause Only	Pressing  will pause without adding a mark.
Pause & Mark	Pressing  will pause and add a mark.
Mark Only	Pressing  will add a mark without pausing.



Setting the keys held (Key Hold Target)

Use the hold function to prevent misoperation during recording. Press  +  to turn it on/off. Follow these instructions to set which keys are disabled by the hold function.

1. Press .

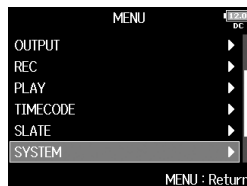
2. Use  to select SYSTEM, and press .



3. Use  to select Key Hold Target, and press .

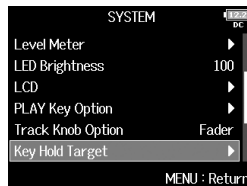

4. Use  to select the keys held, and press .

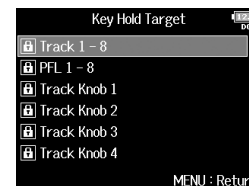



HINT

You can select Track 1-8, PFL 1-8, Track Knob 1-8, Slate Mic, Slate Tone, Encoder, MENU, HP Volume, REW, STOP, FF, PLAY and REC.

5. Press .



HINT

- Even when hold is on for "STOP" and "Track1-8", you can press  +  to turn the hold function off.
- Operation using the **FRC-8** and F8 Control is possible even when the hold function is on.



Checking SD card information (Information)

You can check the size and free space of SD cards.

1. Press .

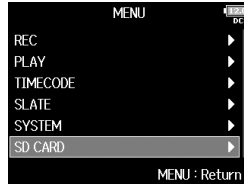
2. Use  to select SD CARD, and press .



3. Use  to select Information, and press .

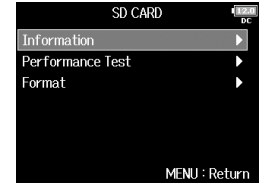



A screenshot of the 'Information' screen. The title is 'Information' and there is a 'DC' indicator in the top right. The screen displays information for two SD cards: SD1:F8_SD1 and SD2:F8_SD2. The information includes Free space, Size, and Remaining recordable time. At the bottom right, it says 'MENU : Return'.

Volume label	Free:	Size:	Remain:	Free space	Size	Remaining recordable time
SD1:F8_SD1	1.83GB	1.86GB	003h48			
SD2:F8_SD2	1.82GB	1.84GB	003h47			



Testing SD card performance (Performance Test)

You can test whether an SD card can be used with the **F8**. The QuickTest is basic, and the FullTest checks the entire SD card.

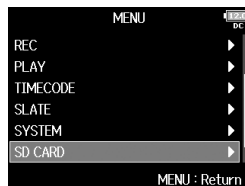

1. Press .

2. Use  to select SD CARD,
and press .

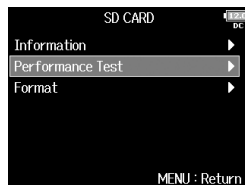

3. Use  to select
Performance Test,
and press .



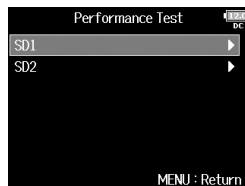

4. Use  to select the SD
card to test, and press .





► Continue to one of the following procedures.

Conducting a quick test.....	P.173
Conducting a full test.....	P.174

Conducting a quick test

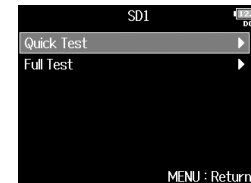
5. Use  to select Quick
Test, and press .



6. Use  to select Yes,
and press .

The card performance test will start. The test should take about 30 seconds.

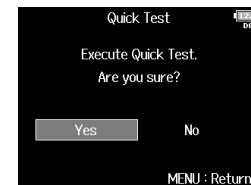

Testing SD card performance (Performance Test) (continued)

7. The test completes.

The result of the evaluation will be shown.

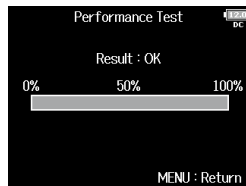

8. Press to stop the test.

NOTE

Even if a performance test result is "OK", there is no guarantee that writing errors will not occur. This information is just to provide guidance.

Conducting a full test

5. Use to select Full Test, and press .

The amount of time required for the full test will be shown.

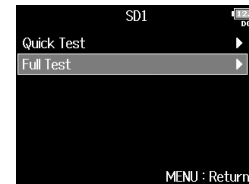

6. Use to select Yes, and press .

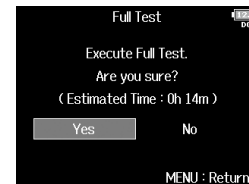

7. The test completes.

The result of the evaluation will be shown.

If the access rate MAX reaches 100%, the card will fail (NG).

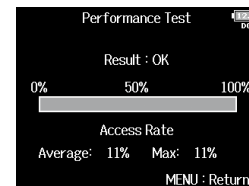

8. Press to stop the test.



NOTE

- You can press  to pause and resume the test.
- Even if a performance test result is "OK", there is no guarantee that writing errors will not occur. This information is just to provide guidance.



Formatting SD cards (Format)

SD cards must be formatted for use with the **F8**.

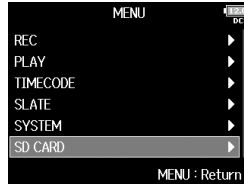

1. Press .

2. Use  to select SD CARD,
and press .



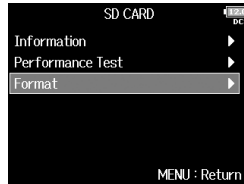

3. Use  to select Format,
and press .

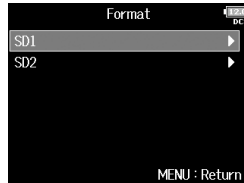

4. Use  to select the card to
initialize, and press .



5. Use  to select Yes,
and press .

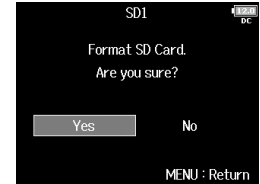



NOTE

- Before using SD cards that have just been purchased or that have been formatted by a computer, they must be formatted by the **F8**.
- Be aware that all data previously saved on an SD card will be deleted when it is formatted.



Checking the F8 Shortcut List

The **F8** has a shortcut feature that allows quick access to various functions. See the “List of shortcuts” (→ P. 190) for information about the shortcut functions.

1. Press .

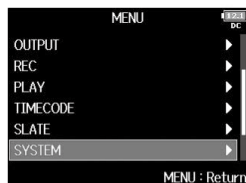
2. Use  to select SYSTEM,
and press .



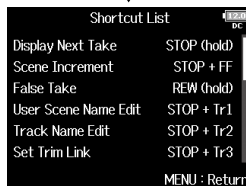

3. Use  to select Shortcut
List, and press .





Backing up and loading **F8** settings (Backup/Load Settings)

F8 settings can be backed up to and loaded from SD cards.

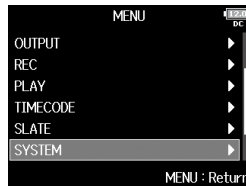

1. Press .

2. Use  to select SYSTEM,
and press .

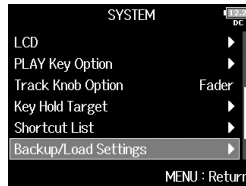

3. Use  to select
Backup/Load Settings,
and press .



4. Use  to select the SD
card to use for backup/
loading, and press .

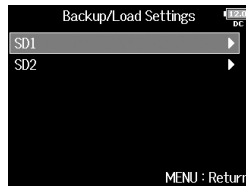



► Continue to one of the following procedures.

Backing up P.178

Loading. P.179

Backing up

This saves a backup file to the "F8_SETTINGS" folder in the root directory of the SD card.

5. Use  to select Backup
and press .

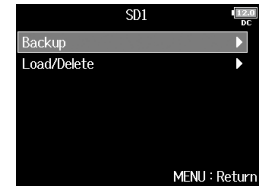

6. Edit the name of the file
saved.

See "Character input screen"
(→ P.13) for how to input
characters.





HINT

The extension of the saved backup file is ".ZSF".



Backing up and loading **F8** settings (Backup/Load Settings) (continued)

Loading

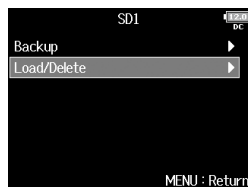

You can load a backup file that is saved in the "F8_SETTINGS" folder in the root directory of the SD card.

- 5.** Use  to select Load/
Delete, and press .

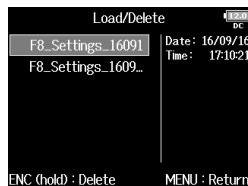

- 6.** Use  to select the file to
load, and press .



- 7.** Use  to select Yes,
and press .

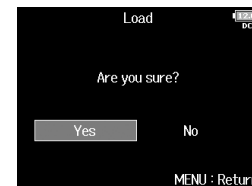



HINT

You can press and hold  to delete a file. Deleting a file will completely erase its data.

Restoring default setting values (Factory Reset)

You can restore the factory default settings.

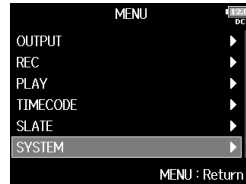

1. Press .

2. Use  to select SYSTEM,
and press .

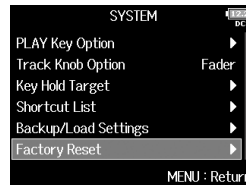

3. Use  to select Factory
Reset, and press .



4. Use  to select Yes,
and press .

The settings will be reset and the power will automatically turn off.





NOTE

Input volume knob settings will not be reset.



Checking the firmware version (Firmware Version)

You can check the firmware version.

1. Press .

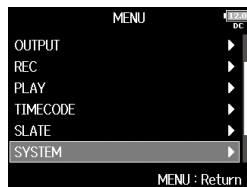
2. Use  to select SYSTEM,
and press .



3. Use  to select Firmware
Version, and press .

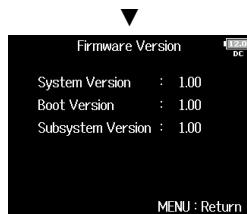
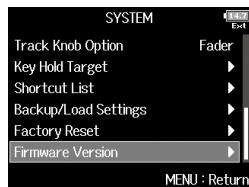

Updating the firmware

The **FB** firmware can be updated to the latest versions.

The latest update file can be downloaded from the ZOOM website (www.zoom.co.jp).

1. Install new batteries in the **FB** or connect the dedicated AC adapter to the DC IN connector.

NOTE



Upgrading is not possible if the remaining battery power is low. In this case, replace the batteries with new ones or use the adapter.

2. Copy the update file to the root directory on an SD card.

3. Load the SD card into the SD CARD 1 slot, and turn the power on while pressing .

NOTE

If an SD card is loaded in the SD CARD 2 slot, eject it first.

4. Use  to select Yes, and press .

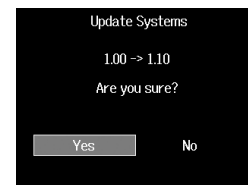

NOTE

Do not turn the power off or remove the SD card during the update. Doing so could cause the **FB** to become unstartable.

5. After the update completes, turn the power off.

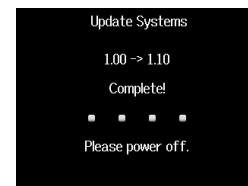

Troubleshooting

If you think that the **F8** is operating incorrectly, check the following items first.

Recording/playback trouble

- ◆ There is no sound or output is very quiet
 - Check the connections to your monitoring system and its volume setting.
 - Confirm that the volume of the **F8** is not too low. (→ P.75)
- ◆ No sound from connected equipment or inputs or it is very quiet
 - If you are using a mic capsule, confirm that it is oriented correctly.
 - Check the input level settings. (→ P.27)
 - If a CD player or other device is connected to an input jack, raise the output level of that device.
 - Check the input signal monitoring settings. (→ P.75)
 - Check the phantom power and plug-in power settings. (→ P.90, P.93)
 - Check the headphone, MAIN OUT 1/2 and SUB OUT 1/2 routing settings. (→ P.108, P.122-123)
- ◆ Recording is not possible
 - Confirm that track keys are lit red.
 - Confirm that the SD card has free space. (→ P.172)
 - Confirm that an SD card is loaded properly in a card slot.
 - If "Card Protected!" appears on the display, the SD card write-protection is enabled. Slide the lock switch on the SD card to disable write-protection.

- ◆ The recorded sound cannot be heard or is very quiet
 - Confirm that the volume levels of the tracks are not too low. (→ P.52)
 - Confirm that track keys are lit green during playback.

Other trouble

- ◆ Computer does not recognize the **F8** even though it is connected to the USB port
 - Confirm that the operating system is compatible. (→ P.144)
 - The operation mode must be set on the **F8** to allow the computer to recognize the **F8**. (→ P.145)
- ◆ Battery operation time is short

Making the following settings increase the battery operation time.

 - Set the power supply used correctly. (→ P.22)
 - Turn unnecessary tracks off. (→ P.27)
 - Turn unnecessary outputs off. (→ P.114)
 - Set the phantom power voltage to 24V. (→ P.91)
 - Disable phantom power during playback. (→ P.92)
 - Turn timecode off if not using it. (→ P.127)
 - Reduce the LED brightness. (→ P.166)
 - Reduce the display brightness. (→ P.167)
 - Set the display to dim when not used for some time. (→ P.168)
 - Reduce the sampling rate used to record files. (→ P.30)
 - Due to their characteristics, using nickel metal hydride batteries (especially high-capacity ones) or lithium batteries should enable longer use than alkaline batteries.

Detailed product diagrams

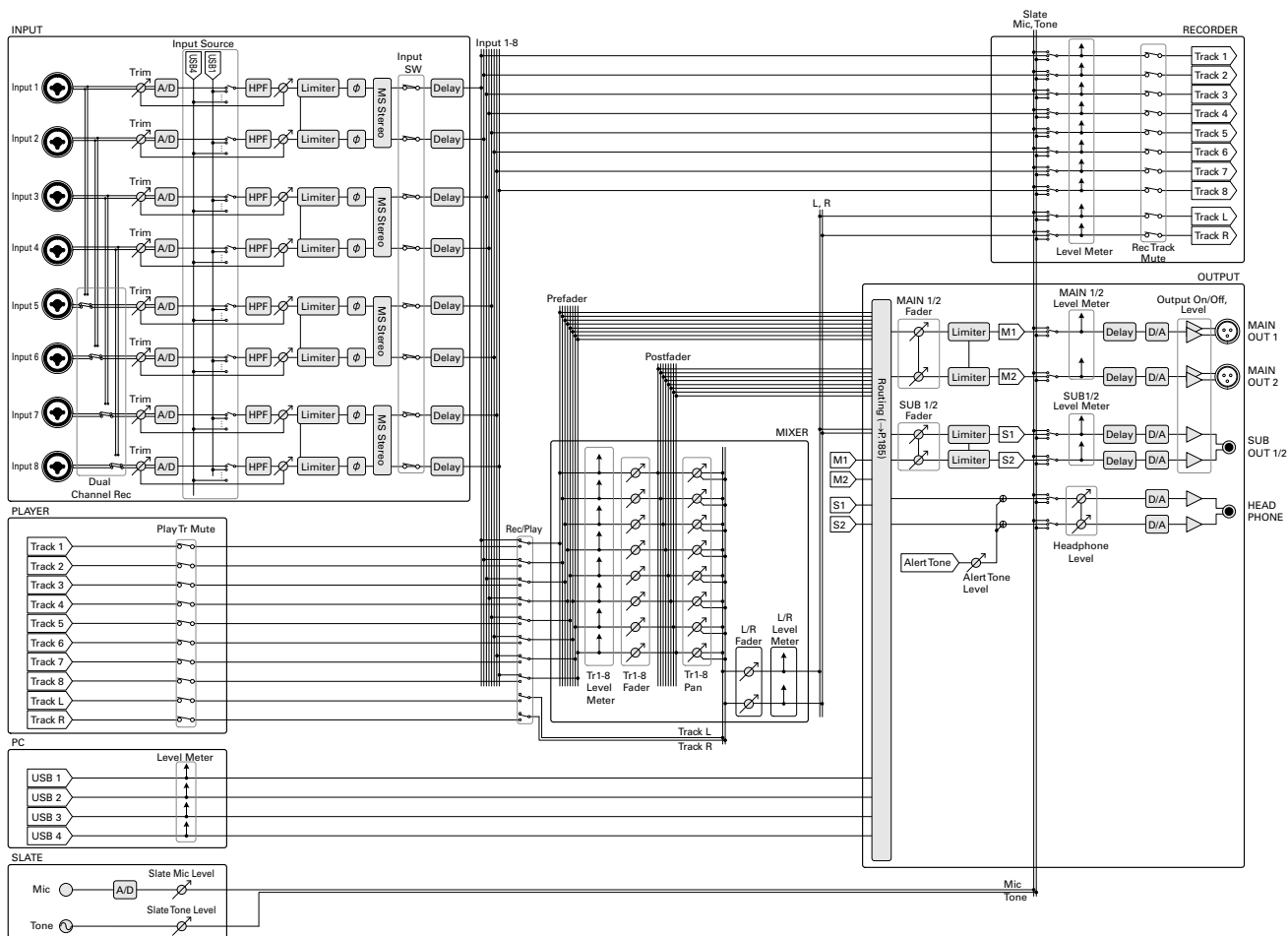

Routing

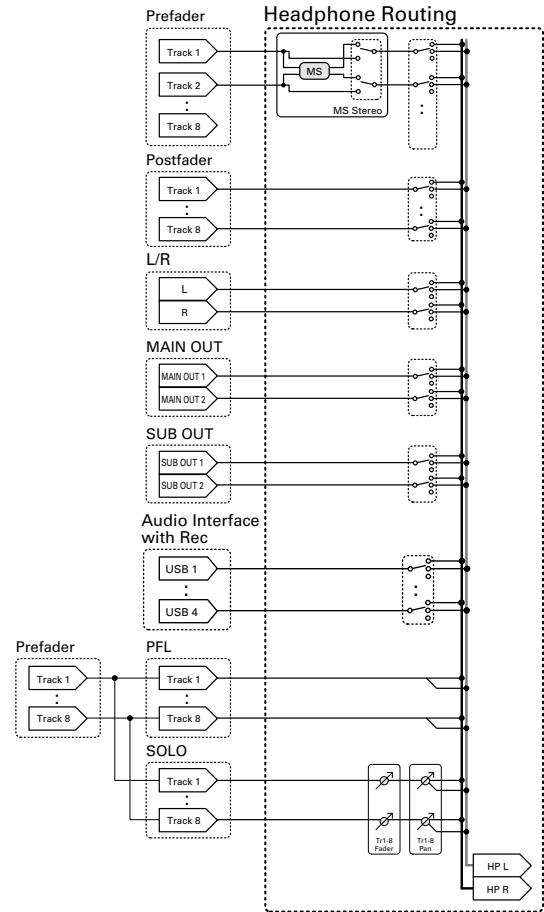
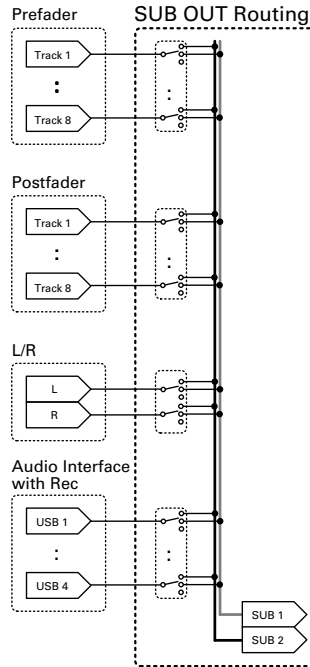
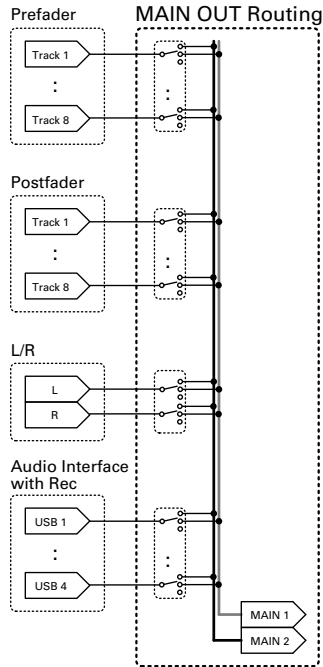

Metadata list

Metadata contained in BEXT chunks in WAV files

Tag	Explanation	Remarks
SPEED=	Frame rate	MENU > TIMECODE > Timecode > FPS
TAKE=	Take number	
UBITS=	User bits	MENU > TIMECODE > Timecode > Ubits
SCENE=	Scene name	MENU > META DATA (for NextTake) > Scene Name Mode MENU > META DATA (for NextTake) > User Scene Name MENU > FINDER > Option > Meta Data Edit > Scene MENU > FINDER > Option > Rename
TAPE=	Name of recording destination folder	MENU > FINDER (Recording destination folder name) MENU > FINDER > Option > Meta Data Edit > Folder (Tape) Name
CIRCLED=	Circled take	MENU > FINDER > Option > Meta Data Edit > Circle
TRL=	Left track name	Track names are written as follows. TRL = left track, TRR = right track TR1 = track 1, TR2 = track 2...TR8 = track 8 During dual channel recording, tracks 1–4 are written to tracks 5–8.
TRR=	Right track name	
TR1=	Track 1 name	
TR2=	Track 2 name	
TR3=	Track 3 name	
TR4=	Track 4 name	
TR5=	Track 5 name	
TR6=	Track 6 name	
TR7=	Track 7 name	
TR8=	Track 8 name	
NOTE=	Take note	MENU > META DATA (for NextTake) > Note MENU > FINDER > Option > Meta Data Edit > Note

Metadata contained in iXML chunks in WAV files

iXML master tag	iXML sub tag	Written	Read	Remarks
<PROJECT>		○	○	MENU > FINDER (SD card root folder) MENU > FINDER > Option > Meta Data Edit > Project Name
<SCENE>		○	○	MENU > META DATA (for NextTake) > Scene Name Mode MENU > META DATA (for NextTake) > User Scene Name MENU > FINDER > Option > Meta Data Edit > Scene MENU > FINDER > Option > Rename
<TAKE>		○	○	MENU > FINDER > Option > Meta Data Edit > Take MENU > FINDER > Option > Rename
<TAPE>		○	○	MENU > FINDER (recording destination folder name) MENU > FINDER > Option > Meta Data Edit > Folder (Tape) Name
<CIRCLED>		○	○	MENU > FINDER > Option > Meta Data Edit > Circle
<WILDTRACK>		x	x	
<FALSE START>		x	x	
<NO GOOD>		x	x	
<FILE_UID>		○	x	
<UBITS>		○	x	MENU > TIMECODE > Timecode > Ubits
<NOTE>		○	○	MENU > META DATA (for NextTake) > Note MENU > FINDER > Option > Meta Data Edit > Note
<BEXT>		x	x	
<USER>		x	x	

Metadata list (continued)

iXML master tag	iXML sub tag	Written	Read	Remarks
<SPEED>				
<SPEED>	<NOTE>	o	x	
<SPEED>	<MASTER_SPEED>	o	o	MENU > TIMECODE > Timecode > FPS
<SPEED>	<CURRENT_SPEED>	o	x	MENU > TIMECODE > Timecode > FPS
<SPEED>	<TIMECODE_RATE>	o	x	MENU > TIMECODE > Timecode > FPS
<SPEED>	<TIMECODE_FLAG>	o	x	MENU > TIMECODE > Timecode > FPS
<SPEED>	<FILE_SAMPLE_RATE>	o	x	MENU > REC > Sample Rate
<SPEED>	<AUDIO_BIT_DEPTH>	o	x	MENU > REC > WAV Bit Depth
<SPEED>	<DIGITIZER_SAMPLE_RATE>	o	x	MENU > REC > Sample Rate
<SPEED>	<TIMESTAMP_SAMPLES_SINCE_MIDNIGHT_HI>	o	x	
<SPEED>	<TIMESTAMP_SAMPLES_SINCE_MIDNIGHT_LO>	o	x	
<SPEED>	<TIMESTAMP_SAMPLE_RATE>	o	x	MENU > REC > Sample Rate

iXML master tag	iXML sub tag	Written	Read	Remarks
<SYNC_POINT_LIST>				
<SYNC_POINT>	<SYNC_POINT_TYPE>	x	x	
<SYNC_POINT>	<SYNC_POINT_FUNCTION>	x	x	
<SYNC_POINT>	<SYNC_POINT_COMMENT>	x	x	
<SYNC_POINT>	<SYNC_POINT_LOW>	x	x	
<SYNC_POINT>	<SYNC_POINT_HIGH>	x	x	
<SYNC_POINT>	<SYNC_POINT_EVENT_DURATION>	x	x	

iXML master tag	iXML sub tag	Written	Read	Remarks
<HISTORY>				
<HISTORY>	<ORIGINAL_FILENAME>	o	x	
<HISTORY>	<PARENT_FILENAME>	x	x	
<HISTORY>	<PARENT_UID>	x	x	

iXML master tag	iXML sub tag	Written	Read	Remarks
<FILE_SET>				
<FILE_SET>	<TOTAL_FILES>	o	x	
<FILE_SET>	<FAMILY_UID>	o	x	
<FILE_SET>	<FAMILY_NAME>	x	x	
<FILE_SET>	<FILE_SET_START_TIME_HI>	x	x	
<FILE_SET>	<FILE_SET_START_TIME_LO>	x	x	
<FILE_SET>	<FILE_SET_INDEX>	o	x	

iXML master tag	iXML sub tag	Written	Read	Remarks
<TRACK_LIST>				
<TRACK_LIST>	<TRACK_COUNT>	o	x	
<TRACK>	<CHANNEL_INDEX>	o	x	
<TRACK>	<INTERLEAVE_INDEX>	o	x	
<TRACK>	<NAME>	o	o	MENU > META DATA (for Next Take) > Track Name MENU > FINDER > Option > Meta Data Edit > Track Name
<TRACK>	<FUNCTION>	x	x	

o = YES x = NO

Metadata and ID3 fields contained in MP3 files

Metadata	ID3 field	Format
Timecode	Artist Name	TC=[HH:MM:SS:FF]
Scene name, take number	TrackTitle	SC=[scene name]TK=[take number]
Frame rate, file length (time)	Album Title	FR=[frame rate] D=[file length (time)]

List of shortcuts

Home Screen





Shortcut	Explanation
Press and hold	Show the name that will be given to the next take recorded. Example: Scene001-T002
+	Advance the scene number by 1 (when the Home Screen is open).
Press and hold	Move the previously recorded take to the FALSE TAKE folder (when the Home Screen is open).
Press and hold	The number given to the next recorded take can be increased or decreased by one when the Home Screen is open.
+ 1	Open the MENU > META DATA (for Next Take) > User Scene Name screen.
+ 2	Open the MENU > META DATA (for Next Take) > Track Name screen. During recording, the key does not need to be used.
+ 3	Open the MENU > INPUT > Trim Link screen. During recording, the key does not need to be used.
+ 4	Open the MENU > META DATA (for Next Take) > Note screen. During recording, the key does not need to be used.
+ 5	Clear the level meter clipping indicators. During recording, the key does not need to be used.
+ 6	Open the L/R track fader settings screen. During recording, the key does not need to be used.

Shortcut	Explanation
+ 7	Open the MENU > OUTPUT > Headphone > Headphone Routing screen. During recording, the key does not need to be used.
+ 8	Use to disable the keys set with "Key Hold Target". During recording, the key does not need to be used.
+ (Track 1)	Circle the currently selected take.
+ (Track 2)	Open MENU > TIMECODE > Timecode screen.

Mixer Screen

Shortcut	Explanation
Press and hold 	Reset the selected pan/fader to the default value (when the Home Screen mixer is open). If already set to its default value, selecting a fader mutes the track.

Character input screen

Shortcut	Explanation
Press and turn 	Move the cursor vertically on a character input screen keyboard.
 + 	Delete a character on the character input screen.
 + 	Move the cursor to "Enter" on the character input screen keyboard.

Routing screen

Shortcut	Explanation
Press and turn 	Move the cursor vertically

Specifications

Recording media		Dual SD card slots support 16MB–2GB SD cards, 4GB–32GB SDHC cards and 64GB–512GB SDXC cards		
Inputs	INPUT 1–8	Connectors	XLR/TRS combo jacks (XLR: 2 hot, TRS: TIP hot)	
	XLR inputs (MIC)	Input gain	+10 – +75 dB	
		Input impedance	3.3 k Ω	
		Maximum input level	+14 dBu (at 0 dBFS, limiter ON)	
		Phantom power	+24/+48V 10mA maximum for each channel	
	TRS inputs (LINE)	Input gain	-10 – +55 dB	
		Input impedance	28 k Ω	
		Maximum input level	+24 dBu (at 0 dBFS, limiter ON)	
	Equivalent input noise	–127 dBu or less (A-weighted, +75dB input gain, 150 Ω input)		
	Frequency characteristics	10 Hz – 80 kHz +0.5dB/–1dB (192kHz sampling rate)		
A/D dynamic range	120 dB typ (–60dBFS input, A-weighted)			
Crosstalk	–90 dB or less (between adjacent channels, 1kHz)			
MIC IN	ZOOM mic capsule input (use disables Inputs 1/2)			
SLATE MIC	Built-in mic for voice memos can be assigned to tracks freely			
Outputs	MAIN OUT 1/2	Connectors	TA3 connectors, balanced output (2: hot)	
		Output impedance	150 Ω or less	
		Reference output level	–10 dBV (normal output level), –40 dBV (mic output level), 1 kHz, 600 Ω load	
		Maximum output level	+10 dBV (normal output level), -20 dBV (mic output level), 1 kHz, 600 Ω load	
	SUB OUT 1/2	Connector	3.5mm stereo mini unbalanced output jack	
		Output impedance	100 Ω or less	
		Reference output level	–10 dBV (normal output level), –40 dBV (mic output level), 1 kHz, 10k Ω load	
		Maximum output level	+10 dBV (normal output level), -20 dBV (mic output level), 1 kHz, 10k Ω load	
	HEADPHONE	Connector	1/4" unbalanced stereo output jack	
		Output impedance	15 Ω or less	
Maximum output level		100mW + 100mW (32 Ω load)		
D/A dynamic range	106 dB typ (–60dBFS input, A-weighted)			

Recording formats	When WAV selected	
	Supported formats	44.1/47.952/48/48.048/88.2/96/192kHz, 16/24-bit, mono/stereo//2-10ch poly, BWF and iXML
	Maximum simultaneous recording tracks	10 (8 inputs + stereo mix) 8 (at 192kHz sampling rate)
	When MP3 selected	
	Supported formats	128/192/320kbps, 44.1/48kHz, ID3v1 tags
	Maximum simultaneous recording tracks	2
Recording time	Using a 32GB card	
	30:51:00 (48kHz/24-bit stereo WAV)	
	7:42:00 (192kHz/24-bit stereo WAV)	
Timecode	Connector	BNC
	Modes	Off, Int Free Run, Int Record Run, Int RTC Run, Ext, Ext Auto Rec (audio clock can be synchronized to timecode)
	Frame rates	23.976ND, 24ND, 25ND, 29.97ND, 29.97D, 30ND, 30D
	Precision	±0.2 ppm
	Supported input levels	0.2 – 5.0 Vpp
	Input impedance	4.6 kΩ
	Output level	3.3 Vpp
Output impedance	50 Ω or less	
Power supplies	Batteries: 8 AA	
	AC adapter: AD-19 DC12V 2A (center plus)	
	External DC power supply: HIROSE HR10A-7R-4S 4-pin connector (1 pin: -, 4 pin: +), 9–16V	

Specifications (continued)

Continuous recording time	When recording 2 channels at 48kHz/16-bit to SD1 with MAIN/SUB OUT OFF, TIME CODE OFF, LED/LCD Brightness 5, 32Ω headphones, PHANTOM OFF	
	Alkaline batteries	8.5 hours or more
	NiMH (2450mAh)	10 hours or more
	Lithium batteries	12.5 hours or more
	When recording 8 channels at 48kHz/24-bit to SD1 with MAIN/SUB OUT OFF, TIME CODE OFF, LED/LCD Brightness 5, 32Ω headphones, PHANTOM OFF	
	Alkaline batteries	4.5 hours or more
	NiMH (2450mAh)	6 hours or more
	Lithium batteries	8.5 hours or more
	When recording 8 channels at 192kHz/24-bit to SD1 with MAIN/SUB OUT ON, TIME CODE Int Free Run, LED/LCD Brightness 60, 32Ω headphones, PHANTOM 48V	
	Alkaline batteries	1 hour or more
	NiMH (2450mAh)	2 hours or more
	Lithium batteries	3 hours or more
Display	2.4" full-color LCD (320x240)	
USB	Mass storage operation	
	Class	USB 2.0 High Speed
	Multi Track audio interface operation (driver required for Windows, not required for Mac)	
	Class	USB 2.0 High Speed
	Specifications	44.1/48/88.2/96kHz sampling rate, 16/24-bit bit rate, 8 in/4 out
	Stereo Mix audio interface operation (no driver required)	
	Class	USB 2.0 Full Speed
	Specifications	44.1/48kHz sampling rate, 16-bit bit rate, 2 in/2 out
	Audio Interface with Rec: (driver required for Windows, not required for Mac)	
	Class	USB 2.0 High Speed
Specifications	44.1/48 kHz sampling rate, 16/24-bit bit rate, 10 in/4 out	
	Note: iOS device audio interface operation supported (stereo mode only)	
Power consumption	12 W	
External dimensions	Main unit: 7.0 in. (W) × 5.5 in. (D) × 2.1 in. (H) 178.2 mm (W) × 140.3 mm (D) × 54.3 mm (H)	
Weight (main unit only)	2.1 pounds (960 g)	

For U.S.A. FCC regulation warning

This equipment has been tested and found to comply with the limits for a Class B digital device, pursuant to Part 15 of the FCC Rules. These limits are designed to provide reasonable protection against harmful interference in a residential installation. This equipment generates, uses and can radiate radio frequency energy and, if not installed and used in accordance with the instructions, may cause harmful interference to radio communications. However, there is no guarantee that interference will not occur in a particular installation. If this equipment does cause harmful interference to radio or television reception, which can be determined by turning the equipment off and on, the user is encouraged to try to correct the interference by one or more of the following measures:

- Reorient or relocate the receiving antenna.
- Increase the separation between the equipment and receiver.
- Connect the equipment to an outlet on a circuit different from that to which the receiver is connected.
- Consult the dealer or an experienced radio/TV technician for help.

FCC CAUTION

Changes or modifications not expressly approved by the party responsible for compliance could void the user's authority to operate the equipment. This transmitter must not be co-located or operated in conjunction with any other antenna or transmitter.

For U.S.A. and CANADA

This device complies with part 15 of the FCC Rules and Industry Canada license-exempt RSS standard(s). Operation is subject to the following two conditions: (1) This device may not cause harmful interference, and (2) this device must accept any interference received, including interference that may cause undesired operation.

This equipment complies with FCC/IC radiation exposure limits set forth for an uncontrolled environment and meets the FCC radio frequency (RF) Exposure Guidelines and RSS-102 of the IC radio frequency (RF) Exposure rules. This equipment has very low levels of RF energy that are deemed to comply without testing of specific absorption ratio (SAR).

For CANADA

Le présent appareil est conforme aux CNR d'Industrie Canada applicables aux appareils radio exempts de licence. L'exploitation est autorisée aux deux conditions suivantes : (1) l'appareil ne doit pas produire de brouillage, et (2) l'utilisateur de l'appareil doit accepter tout brouillage radioélectrique subi, même si le brouillage est susceptible d'en compromettre le fonctionnement.

Cet équipement est conforme aux limites d'exposition aux rayonnements énoncées pour un environnement non contrôlé et respecte les règles d'exposition aux fréquences radioélectriques (RF) CNR-102 de l'IC. Cet équipement émet une énergie RF très faible qui est considérée conforme sans évaluation du débit d'absorption spécifique (DAS).

For EU Countries



Declaration of Conformity

Label is located at the bottom of the unit.



ZOOM CORPORATION

4-4-3 Kanda-surugadai, Chiyoda-ku, Tokyo 101-0062 Japan

<http://www.zoom.co.jp>